



PORSCHE



The new Panamera

Thrilling Contradictions





Concept	4	Personality	80
The Panamera model range	5	Interior	81
Design	7	Communication	89
Interior	10	Sound systems	91
Engineering	11	Assistance systems	97
		Luggage compartment	106
Models	13	Individuality	107
Panamera and Panamera 4	15	Colors	111
Panamera S and Panamera 4S	21	Options	119
Panamera S E-Hybrid	27	Porsche Exclusive	135
Panamera GTS	35	Porsche Car Configurator	136
Panamera Turbo	41		
Performance	47	Porsche Driving Experience	137
Drive	50	Porsche European Delivery	138
Transmission	55	Panorama	139
Chassis	58	Summary	142
Balance	68	Technical data	143
Lighting	70		
Safety	74	Index	149
Environment	78		





Day and dream. Concept.

A sports car of uncompromising performance. A sedan of uncompromising luxury. These aims couldn't be further apart, yet the new Porsche Panamera somehow incorporates them both, seamlessly. It is a performance sedan offering sumptuous comfort for four. It is, at the same time, a Porsche—capable of eliciting driving pleasure that is the stuff of dreams. Yet equally capable of being driven every day. The power of contradiction? Porsche has used it to create something utterly distinctive: the Panamera.

A controversial idea. Pursued to its fullest. Hasn't that always been the Porsche Way?

The Panamera model range.

In the very beginning, there were doubters. When Ferdinand Porsche and his son designed the first car to bear the family name, few could grasp how this radical new concept would evolve into a game-changing sports car. Decades later, when the Porsche Panamera was unveiled, again there were skeptics. A four-door Porsche?

With luggage but without compromise? That'll never work, they said. But it did, as we now know. The Panamera gave the luxury sports sedan a new lease on life and silenced the doubters.

Job done, we could have said. But Porsche wouldn't be Porsche if we rested on our laurels. Our more than 30,000 racing victories could not have been achieved if we'd been satisfied with conventional thinking. By focusing on what we call Intelligent Performance, our ideas continually improve.

The result is the new Panamera model range. With a design evolved to enhance aerodynamics and aesthetics. With engines that offer not just power, but powerful efficiencies. And with a spacious cabin integrating new technologies that let you connect your worlds.





Panamera S E-Hybrid with 20-inch Panamera Sport wheel, Panamera Turbo with 20-inch 911 Turbo II wheels

One of our most important design tools: timelessness.

Design.

When we create a sports car, our designers could focus on the here and now. But we have never been concerned with mimicking current fashion. Creating something truly significant we believe means sticking to principles, preserving what we've proven is worthy, and using this as the platform for our new ideas.

With the new Panamera models, the evolution of its design is driven by function. Visible examples include the enlarged air intakes in the front end. These help to provide optimal cooling of the engine and brakes. The fact that they also look great is a welcome bonus.

In its proportions and use of form, the new Panamera is typical of any Porsche. But in its details, it is decidedly more precise. Sharper. Edgier. The fenders are higher than the hood and they add muscle at the rear. The roofline tapers down to the rear.

Seen from the rear, the new Panamera models look more modern, with tauter proportions. The rear end has been restyled, its lines sharpened. The rear window is larger and flatter. It is also wider, just like the automatically deploying spoiler. The LED taillights have become narrower and more crisply defined.

Another illuminating example of the further development of the Panamera design is its standard Bi-Xenon™ headlights. The daytime running lights have been integrated into the main headlight units in the form of four LED spotlights. Like the taillights, they now appear slimmer. Together with the more distinctive “power dome” of the hood, the new side skirts, and exterior mirrors, they lend the Panamera models a sportier look.

Traditional values and a forward-looking design make a successful combination. All that's missing is your own interpretation of the Panamera.

With 15 exterior colors, an extensive range of Leather packages, wheels measuring up to 20 inches, and many more options, you can lend your model an unmistakable character.



Panamera 4 with 20-inch RS Spyder Design wheels, Panamera Turbo with 20-inch 911 Turbo II wheels



Interior of the Panamera Turbo in two-tone Black and Carrera Red, Carbon Fiber interior package, and optional equipment



**The interior may be unorthodox for a sedan.
But not for a Porsche.**

Interior.

The new Panamera model's exquisite interior is designed around four individual seats. This unusual structure offers a high degree of accommodation for four occupants and their luggage, and ensures driving pleasure on both daily commutes and longer journeys.

Of course, the same unconventional thinking applies to the rear hatch. Just as it does to the five circular instruments—long a signature of many Porsche models. With a high-resolution color display and the logical grouping of controls, the cluster enables fast and direct access.

In the rear, even taller passengers will find plenty of headroom and legroom. The rear seats fold down separately to create space for larger items of luggage, including your sports equipment.

You choose the colors and materials yourself. An extensive selection of interior colors, interior packages with various Woods, Aluminum, or Carbon Fiber, and many other personalization options means that your decision may not be an easy one. But the result will be all the more individual.

Conserving fuel. Without cutting back on the adrenaline.

Engineering.

Under the hood of every member of the Panamera family there are innovations designed to enhance responsiveness—and responsibility.

In the Panamera S and Panamera 4S, there is a brand-new generation of engine. Thanks to some intelligent downsizing, the 3.0-liter, twin-turbo V6 engine produces more power output than the naturally aspirated engine of

the previous generation—yet it delivers improved fuel efficiency at the same time.

The Panamera S E-Hybrid is the next major step in fuel-saving hybrid technology. Its new lithium-ion-based high-voltage battery holds more energy content than nickel-metal hydride (NiMH) batteries and can be charged from an external source. A Parallel Full Plug-In Hybrid, the new Panamera S E-Hybrid

combines a progressive drive system, a variety of charging capabilities, intelligent smartphone integration, and efficient performance. On electric power alone, the Panamera S E-Hybrid has a range of up to 22 miles and reaches a maximum track speed of 83 mph. The power of the Panamera S E-Hybrid is transmitted to the road by the 8-speed Tiptronic S.

And in the new Panamera, we now offer a way to make digital technology serve you better. It's called Porsche Car Connect, and it combines with a smartphone app

that enables you to access various data relating to your car and control certain functions remotely. You can see all of the important information about your Panamera whenever you wish—and not only when you're behind the wheel.

The new, optional LED headlights including Porsche Dynamic Light System Plus (PDLS Plus) help to ensure even better visibility. And with Lane Change Assist (LCA), the Lane Departure Warning (LDW), Adaptive Cruise Control including Porsche

Active Safe (PAS), and Surround View, a wealth of new assistance systems is available to you. Systems that, in critical situations, are actually designed to help lower your adrenaline levels.



Panamera S E-Hybrid with Porsche universal charger (AC) and charging dock

What matters when choosing a sports car? Emotion or logic? The impact on the eye or the forces of physics? At Porsche, we believe that, when you allow form to follow function, one emerges from the other. And the design of a Porsche suddenly makes perfect sense.



Beauty and sense. Models.



Your head and your heart. Now they're on the same page.

The new Panamera and the new Panamera 4.

Luxury sedan or sports car? Power or efficiency? Comfort or control? The new Panamera and the new Panamera 4 resolve contradiction as only a Porsche can.

These are unquestionably Porsche sports cars: They look the part, thanks to visual cues that include Bi-Xenon™ headlights, 18-inch Panamera wheels, and a dual exhaust. The standard steel-spring suspension blends the precise handling expected from a Porsche with a high level of ride comfort. Porsche Active

Suspension Management (PASM), an electronic damping-control system, and the Adaptive Air Suspension are available as options. Both models come standard with the Porsche Doppelkupplung (PDK). In the new Panamera, it transfers engine power to the rear axle; in the new Panamera 4, to all four wheels via the active all-wheel drive of Porsche Traction Management (PTM).

These are unquestionably luxury sedans. Within the spacious interior, everything you see and touch blends precision

craftsmanship with clear purpose. Smooth-Finish Leather wraps the rim of the multifunction steering wheel and the PDK gear selector. High-gloss black trim creates a stunning complement to each of the three interior color choices that come standard. Or we offer a high level of personalization through a comprehensive range of interior options. These include a selection of two-tone Leather interiors, as well as other color and material combinations. An automatic rear hatch, automatic climate control, and the Porsche Communication

Management (PCM) are standard. Audio options include the Bose® Surround Sound System or Burmester® High-End Surround Sound System.



Panamera with 18-inch Panamera wheels



Drive Concept

An efficient 3.6-liter, naturally aspirated V6 engine with four overhead camshafts powers the Panamera and Panamera 4. Its lightweight construction translates into responsive performance. Direct Fuel Injection (DFI), VarioCam Plus, a coasting function, and Auto Start Stop all contribute to improving fuel efficiency. A balance shaft ensures smoothness, and integrated dry-sump lubrication helps preserve consistent cooling of the engine.

The engine generates 310 horsepower at 6200 rpm and a maximum torque of 295 lb.-ft. at 3750 rpm. In the new Panamera, the result is a top track speed of 160 mph and acceleration from 0–60 mph in 6.0 seconds. In the new Panamera 4, the figures are a 159-mph top track speed and 5.8 seconds from 0–60 mph.

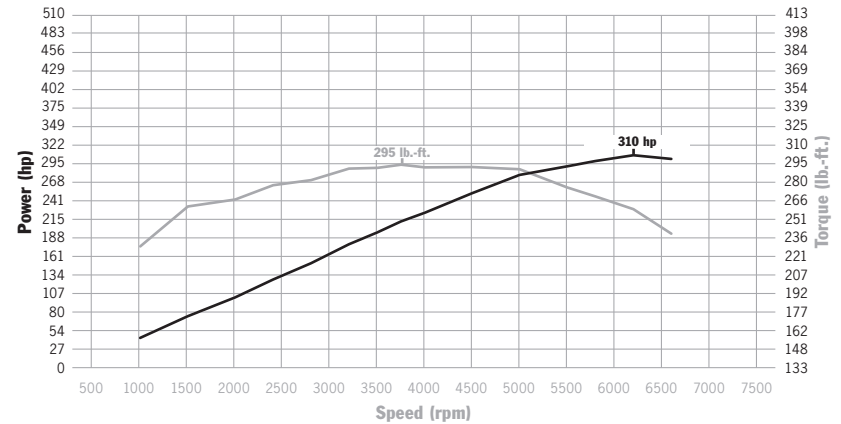

Panamera and Panamera 4: 310 horsepower at 6200 rpm, 295 lb.-ft. at 3750 rpm



Interior of the Panamera in Luxor Beige, Dark Walnut interior package, and optional equipment



Luggage compartment

Selected Key Features of the Standard Specification

- Porsche Doppelkupplung (PDK) with Auto Start Stop function
- Porsche Stability Management (PSM)
- Bi-Xenon™ headlights
- Multifunction steering wheel
- Leather interior
- Porsche Communication Management (PCM) including navigation module
- Bluetooth® Hands-Free Profile (HFP)
- Cruise control
- ParkAssist (front and rear)
- 18-inch Panamera wheels
- Automatic rear hatch

Technical Data

- 3.6-liter, naturally aspirated V6 engine
- 310 horsepower

Panamera:

- 0–60 mph in 6.0 secs
- 160-mph top track speed

Panamera 4:

- 0–60 mph in 5.8 secs
- 159-mph top track speed

Turbocharged power. From the engineers who created the Porsche Turbo.

The new Panamera S and the new Panamera 4S.

These days, it seems car companies are suddenly discovering the concept of turbocharging. At Porsche, we've been perfecting this technology in our production cars since 1974, when we introduced the first Porsche 911 Turbo. That car radically transformed the level of power that could come from a compact 6-cylinder engine. In the new Panamera S and new Panamera 4S, Porsche engineers continue to evolve the science of turbocharging, with stunning effect.

Both models are powered by a newly developed 3.0-liter V6 engine with twin turbochargers. Engine power is transmitted by Porsche Doppelkupplung (PDK). In the new Panamera 4S, it is distributed to all four wheels via the all-wheel drive of Porsche Traction Management (PTM). And both the Panamera S and Panamera 4S come standard with Porsche Active Suspension Management (PASM)—an electronic damping-control system.

From the outside, the new Panamera S models are recognizable by the silver-colored brake calipers, 18-inch Panamera S wheels, and the dual twin-tube exhaust system. Bi-Xenon™ headlights including Porsche Dynamic Lighting System (PDLS), featuring daytime running lights with four integral LED spotlights, are standard on all models.





Drive Concept

Turbocharging isn't just about increased power. It's about enhanced efficiency. That's why the new Panamera S and the new Panamera 4S are now powered by a newly developed 3.0-liter, twin-turbo V6 engine. Though a mere 3.0 liters in displacement, the new twin-turbo engine creates more power output than that of the naturally aspirated engine in the predecessor model. And it does so with lower fuel consumption.

The lightweight construction of the new engine also contributes to its high efficiency. Technologies such as Direct Fuel Injection (DFI), four overhead camshafts, and VarioCam Plus join

forces with two turbochargers to deliver a high degree of efficiency and optimal torque in every engine-speed range.

The result is 420 horsepower at 6000 rpm, and 384 lb.-ft. of torque between 1750 and 5000 rpm. The Panamera S completes the sprint from 0–60 mph in 4.9 seconds and manages a top track speed of 178 mph. The Panamera 4S reaches 60 mph from a standing start in 4.6 seconds and achieves a top track speed of 177 mph.

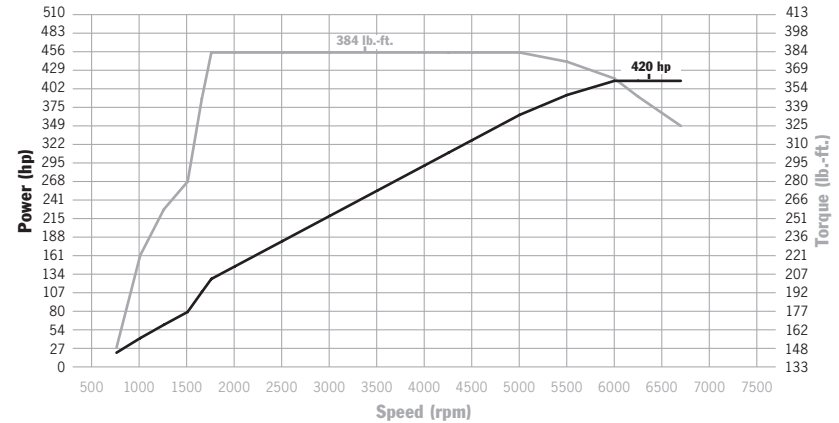

Panamera S and Panamera 4S: 420 horsepower at 6000 rpm, 384 lb.-ft. between 1750 and 5000 rpm



Tailpipe tips of the exhaust system on the Panamera S model



Panamera S with 18-inch Panamera S wheel





Interior of the Panamera 4S in two-tone Agate Grey and Cream, Anthracite Birch interior package, and optional equipment

Selected Key Features of the Standard Specification

- Porsche Doppelkupplung (PDK) with Auto Start Stop function
- Porsche Stability Management (PSM)
- Bi-Xenon™ headlights with PDLs
- Tire Pressure Monitoring System (TPMS)
- Multifunction steering wheel
- Seat heating (front)
- Porsche Communication Management (PCM) including navigation module
- Bluetooth® Hands-Free Profile (HFP)
- Cruise control
- ParkAssist (front and rear)
- Automatically-dimming mirrors
- 18-inch Panamera S wheels
- Automatic rear hatch

Technical Data

- 3.0-liter, twin-turbo V6 engine
- 420 horsepower

Panamera S:

- 0–60 mph in 4.9 secs
- 178-mph top track speed

Panamera 4S:

- 0–60 mph in 4.6 secs
- 177-mph top track speed

The future, as seen through the eyes of Porsche.

The new Panamera S E-Hybrid.

As with many things at Porsche, our application of hybrid power first proved itself on the track, through punishing endurance races like the 24 Hours of LeMans. That's where we've always gone to instill reliability and durability into our innovations.

With the new Panamera S E-Hybrid, Porsche is again transferring race-proven technology from the track to the street. The result is unique among high-end hybrids: electric power that achieves the electrifying performance of a true

sports car. Power is transmitted to the road by the 8-speed Tiptronic S. Precise handling comes from the Adaptive Air Suspension with Porsche Active Suspension Management (PASM) and speed-sensitive Power Steering Plus.

At the same time, with solutions such as Porsche Car Connect smartphone access and control functionalities, and the Porsche universal charger (AC) charging system, Porsche offers intelligent performance. With the Porsche universal charger (AC), you

can top off the Panamera S E-Hybrid model's battery by plugging it into an ordinary electrical socket.

The Panamera S E-Hybrid maintains its visual identity with the "e-hybrid" logo on the front doors, and the "Panamera S" logo on the rear hatch with an Acid Green corona—the same as the needles of the newly developed power meter in the center of the instrument cluster. The brake calipers are also finished in Acid Green. The features it shares with the S model—the exterior design and

the exquisite styling of the interior—are similarly characteristic. And of course, a comprehensive range of personalization options is available.



Panamera S E-Hybrid with 20-inch Panamera Sport wheels



Drive Concept

The Panamera S E-Hybrid is a Parallel Full Plug-In Hybrid. This means that it can be powered by the combustion engine alone, by the electric motor alone, or by both units working together. It's a concept that's been proven since 2011. What's new is that the high-voltage battery can be fully recharged in approximately 2.5 hours via direct connection to a 240-volt household socket. The battery can also be recharged while you are driving, through the process of brake energy recovery known as recuperation—or via the combustion engine. Thanks to innovative lithium-ion technology, its capacity of 9.4 kWh means that it also stores much more energy. The battery is maintenance-free and covered by a 7-year warranty.

The 3.0-liter, supercharged V6 engine is rated at 333 horsepower. Combined with the power from the electric motor,

416 horsepower is delivered to the road at 5500 rpm. With both propulsion sources working together, the new Panamera S E-Hybrid accelerates from 0–60 mph in just 5.2 seconds.

The operating range of the hybrid drive begins with emissions-free and quiet driving at up to a maximum speed of approximately 83 mph and an estimated range of 22 miles. The combustion engine turns over automatically as determined by the operating strategy, or actively in response to the driver depressing the accelerator pedal beyond a specifically defined pressure point. The kick-down point, however, enables the maximum power output available from both propulsion units to be purposefully exploited at the driver’s command. In e-boost mode, the combustion engine

provides assistance for the electric drive—providing a sporty push into the future. In coasting mode, the combustion engine is turned off, allowing the car to glide for some distance under its own momentum—thereby further reducing fuel consumption.

The E-Hybrid concept promises one thing above all: sporty performance with utmost efficiency. The workings of the 3.0-liter, supercharged V6, electric motor, and high-voltage battery are synchronized by the electronic engine management. All processes run smoothly and harmoniously, leaving you to concentrate on what matters the most: driving.

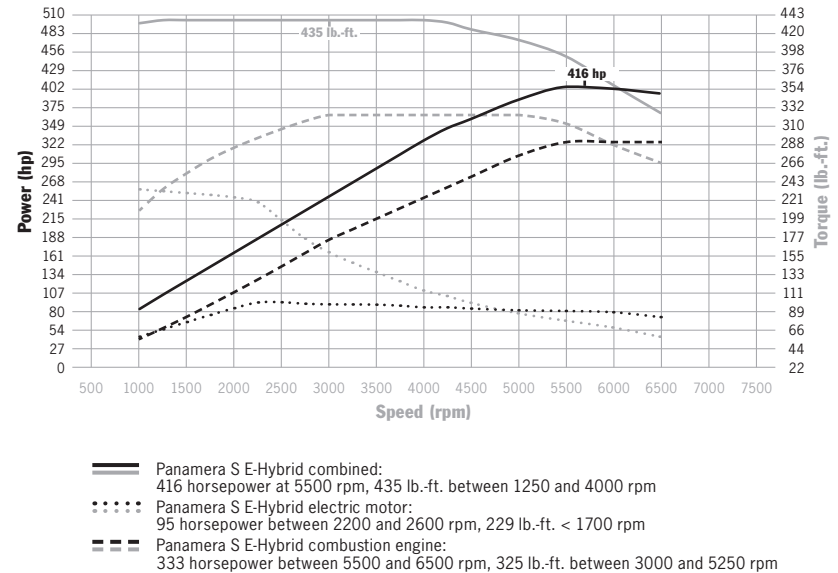

Display Concept

The conventional speedometer in the instrument cluster—traditionally to the left of the tachometer—is replaced by a solution fully tailored to the new Panamera S E-Hybrid. The power meter displays the drive power of the system. It tells you whether your Panamera S E-Hybrid: is being driven electrically or in hybrid mode and informs you of the recuperation power generated under braking. The color display in the instrument cluster shows the energy flow in the system as well as selected driving statistics.

With the Porsche Communication Management (PCM) that's standard, you can view at any time a detailed diagram of your vehicle with energy flow and statistics on the amount of driving without the combustion engine.

Porsche Car Connect

Porsche Car Connect enables you to call up important information about your Panamera S E-Hybrid remotely via a smartphone app. What's your remaining charge time? The app will tell you. Want to see a visual depiction of electric range? Check it out on your

smartphone. You can even set a charge timer with customizable charging times.

With the optional auxiliary climate control, you can now also control the temperature of your Panamera S E-Hybrid from your smartphone. So in advance of any journey, you can begin to heat or cool the interior—with the vehicle stationary and the combustion engine switched off.

Thanks to Porsche Car Connect and your smartphone, you can also locate your Panamera S E-Hybrid at any time from any place.

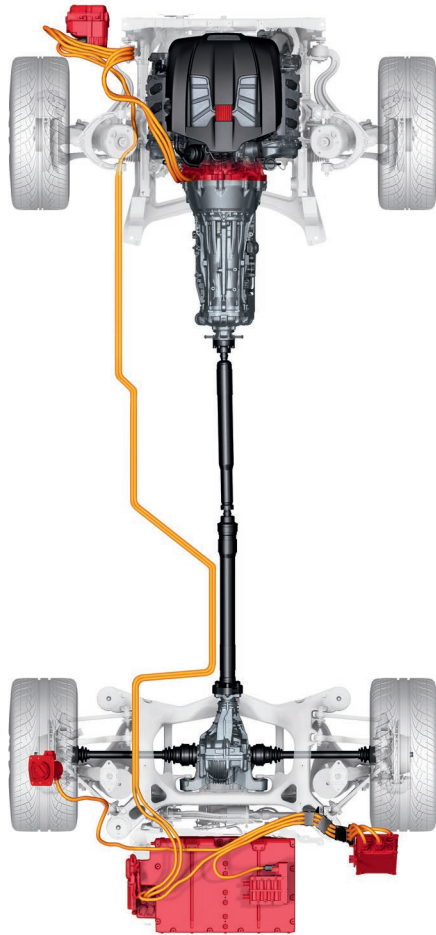

Hybrid components of the Panamera S E-Hybrid



Panamera S E-Hybrid instrument cluster

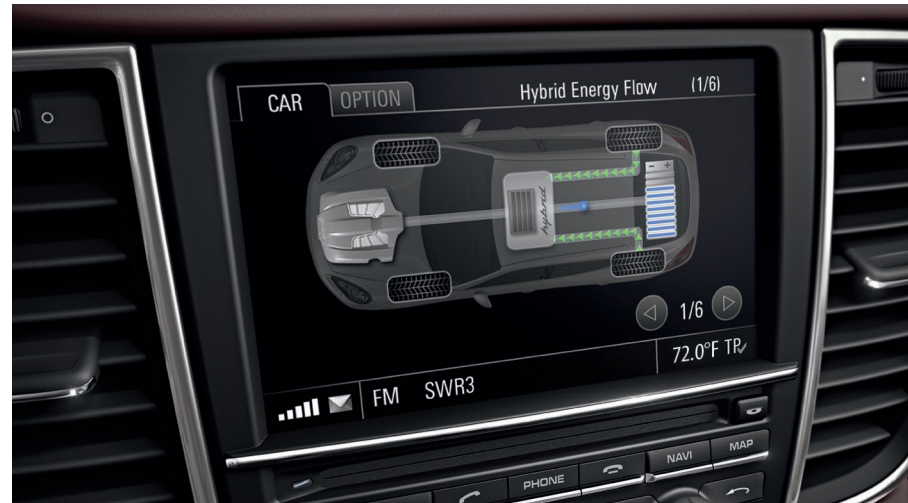

Display of the energy flow in the Porsche Communication Management (PCM)



Panamera S E-Hybrid interior in Marsala, Brushed Aluminum interior package



"e-Power" and "e-charge" buttons

Selected Key Features of the Standard Specification

- Porsche universal charger (AC) including charging dock
- Porsche Car Connect
- 8-speed Tiptronic S
- Adaptive Air Suspension including Porsche Active Suspension Management (PASM)
- Porsche Stability Management (PSM)
- Bi-Xenon™ headlights with PDLs
- Tire Pressure Monitoring System (TPMS)
- Power Steering Plus
- Multifunction steering wheel
- Seat heating (front)
- Porsche Communication Management (PCM) including navigation module
- Bluetooth® Hands-Free Profile (HFP)

- ParkAssist (front and rear)
- Automatically-dimming mirrors
- Rear wiper
- 18-inch Panamera S wheels
- Automatic rear hatch

Technical Data

- Combustion engine, 333 horsepower; electric motor, 95 horsepower; combined 416 horsepower at 5500 rpm
- 0–60 mph in 5.2 secs
- 167-mph top track speed
- 83-mph top electric speed
- 9.4-kWh lithium-ion battery



"e-hybrid" logo on the door

Can three letters intensify the Panamera driving experience?

The new Panamera GTS.

Can three letters intensify the inherent performance of the Panamera? The answer is seen on racetracks and on roads. That's where Porsche has written the abbreviation "GTS" into history—and is how the new Panamera GTS has become the thoroughbred athlete of the family.

The figures sum it up: In the Panamera GTS, the power output achieved by its 4.8-liter, naturally aspirated V8 is 440 horsepower with a maximum torque of 384 lb.-ft. With ram-air induction, the GTS engine is extremely responsive, and with 7-speed Porsche Doppelkupplung (PDK) and the

active all-wheel drive of Porsche Traction Management (PTM), that response is transmitted adeptly to the pavement. The Adaptive Air Suspension lowers the Normal Level ride height by 10 mm, and a Sport exhaust system is standard. The brake system, wheels, front end, and 4-way rear spoiler have been carried over from the Panamera Turbo. The side skirts are styled in matte black. This is driving pleasure the GTS way—accompanied by a thunderous soundtrack.

The sporty characteristics of the new Panamera GTS continue seamlessly into the interior in the form of Leather and Alcantara® and the GTS logo in the

tachometer, on the headrests, and on the door-entry guards in Brushed Aluminum. Alcantara® is the material used for the seat centers of the Adaptive Sport Seats, the armrests of the center console, and the roof liner. The SportDesign steering wheel is standard, and on request you can have the rim finished in black Alcantara®.

Two optional GTS interior packages are available in conjunction with the standard black Leather and Alcantara® interior. They intensify the sporty character of the GTS interior, with the seat belts and the stitching on the dashboard, door waist rails, seats, armrests on the

center console, and doors rendered in Carmine Red or GT Silver. The headrests of all four seats are embroidered with the GTS logo in the same color.



Panamera GTS with 20-inch RS Spyder Design wheels



Drive Concept

The new Panamera GTS is driven by a 4.8-liter, naturally aspirated V8 engine of lightweight construction with integrated dry-sump lubrication. As a naturally aspirated unit, it inherently delivers a remarkably direct response. The maximum engine speed is 7100 rpm. The result is a compelling 440 horsepower and 384 lb.-ft. of torque.

Features specific to the new Panamera GTS include intake camshafts with extended valve lift and a new air-induction system with two additional air-filter modules in the front end. Above 3500 rpm, the flaps on the air-filter modules are opened to allow the engine to breathe more easily. At high driving speeds, pressure is exploited for more power.

The modified engine management has also been fully adapted to the Panamera GTS with the focus on maximum performance, for a more direct response characteristic and even faster gear changing of the PDK. You'll certainly feel it every time you open the throttle. The Sport Chrono Package is integrated as standard. In Sport Plus mode, the race from 0–60 mph lasts a mere 4.2 seconds. The achievable top track speed is 179 mph. The figures reveal performance in pure form.

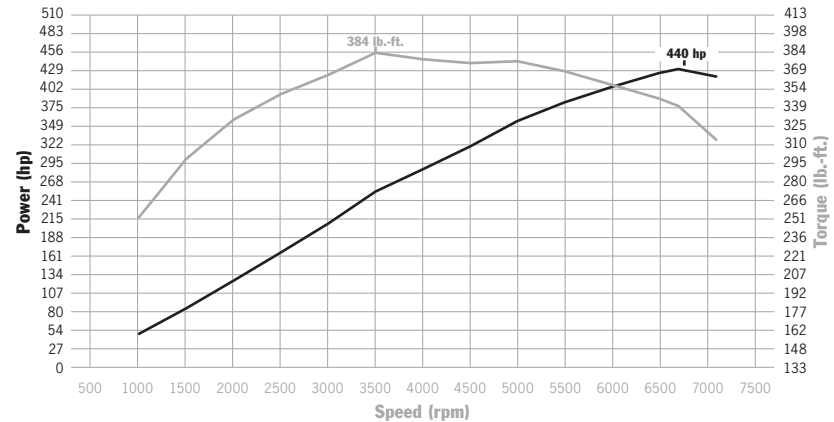

Panamera GTS: 440 horsepower at 6700 rpm, 384 lb.-ft. at 3500 rpm



Panamera GTS interior in black, Carmine Red interior package, Carbon Fiber trim



Panamera GTS with 20-inch RS Spyder Design wheels

Selected Key Features of the Standard Specification

- Porsche Doppelkupplung (PDK) with Auto Start Stop function
- Bi-Xenon™ headlights in black including Porsche Dynamic Light System (PDLS)
- Porsche Traction Management (PTM) active all-wheel drive
- Adaptive Air Suspension (Normal Level, -10 mm) including Porsche Active Suspension Management (PASM)
- Panamera Turbo brake setup with red calipers
- SportDesign steering wheel with paddle shifters
- Sport exhaust system in black
- Sport Chrono Package
- ParkAssist (front and rear)
- Leather interior package
- 18-way Adaptive Sport Seats with memory package
- Adaptive rear spoiler (4-way)

- Tire Pressure Monitoring System (TPMS)
- 19-inch Panamera Turbo II wheels with 5mm spacers at rear axle

Technical Data

- 4.8-liter, naturally aspirated V8 engine
- 440 horsepower
- 0–60 mph in 4.2 secs
- 179-mph top track speed



Tailpipes of the Sport exhaust system in black

520 horsepower unleashes a mighty force. The kind to put a smile on your face.

The new Panamera Turbo.

Extreme performance can take your breath away. Or it can have the calming effect you get when you breathe deeply. Either is possible sitting behind the wheel of the new Panamera Turbo.

Here, comfort and sportiness intertwine without compromise. Its 4.8-liter, twin-turbo V8 engine delivers 520 horsepower and offers a maximum torque of 516 lb.-ft. between 2250 and 4500 rpm. The new 19-inch Panamera Turbo II wheels afford a glimpse of the red calipers

that engage the equally powerful brake system fitted to the Turbo.

The front end features large air intakes to increase the volume of cooling air, while the 4-way adaptive rear spoiler helps to reduce lift at the rear axle. Chrome-colored air outlets are positioned behind the front wheels and the dual twin-tube tailpipes are in the distinctive Turbo design.

Porsche Doppelkupplung (PDK) and Porsche Traction Management (PTM) with

active all-wheel drive and an electronic and map-controlled multiplate clutch are standard on Panamera Turbo. Displays in the instrument cluster and Porsche Communication Management (PCM) inform you of the longitudinal and lateral acceleration forces currently acting on the vehicle. Adaptive Air Suspension including Porsche Active Suspension Management (PASM) enhances sporty performance—or comfort—at the push of a button.

In the interior, the Turbo presents its own interpretation of Porsche style. It offers 14-way power seats with memory, seat heating for all four occupants, Smooth-Finish Leather interior, and the Dark Walnut interior package. Also standard are Porsche Communication Management (PCM) including navigation module, and Bose® Surround Sound System, HD Radio, SiriusXM® Satellite Radio receiver, and the Porsche Entry & Drive System. The Burmester® High-End Surround Sound System is available as an option.



Panamera Turbo with 20-inch 911 Turbo II wheels



Drive Concept

The new Panamera Turbo is powered by a 4.8-liter, twin-turbo V8 engine with Direct Fuel Injection (DFI) and VarioCam Plus. It features two turbochargers arranged in parallel—one for each cylinder bank. Intake air is compressed and then fed to the engine by the respective intercooler for each cylinder bank.

Performance figures: 520 horsepower at 6000 rpm. The maximum torque of 516 lb.-ft. is achieved between 2250 and 4500 rpm. Top track speed is reached at 189 mph. The new Panamera Turbo completes the sprint from 0–60 mph in just 3.9 seconds.

With the Launch Control function of the optional Sport Chrono Package, the clock stops even sooner, at 3.7 seconds. An overboost function temporarily increases the boost pressure produced at full throttle to 568 lb.-ft. between 2500–4000 rpm. Proof that supremacy is synonymous with sheer fun.

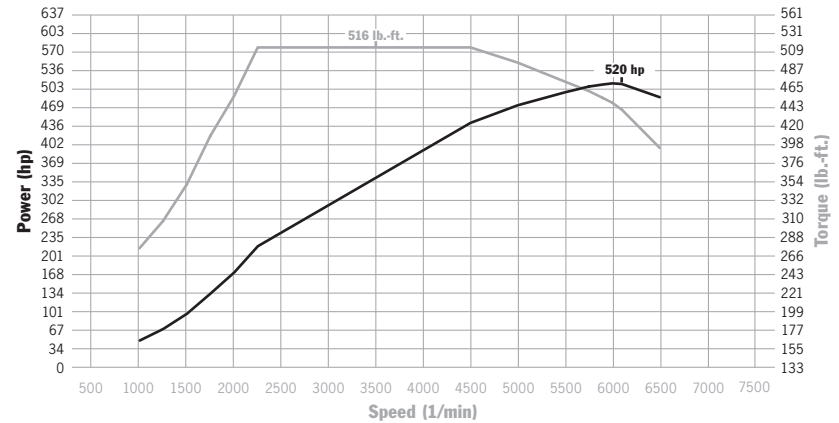

Panamera Turbo: 520 horsepower at 6000 rpm, 516 lb.-ft. between 2250 and 4500 rpm



Adaptive rear spoiler (4-way)



Panamera Turbo with 19-inch Panamera Turbo II wheel





Panamera Turbo interior in two-tone Black and Carrera Red, Carbon Fiber trim, and optional equipment

Selected Key Features of the Standard Specification

- Porsche Doppelkupplung (PDK)
- Adaptive Air Suspension including Porsche Active Suspension Management (PASM)
- Porsche Traction Management (PTM) active all-wheel drive
- Porsche Communication Management (PCM) including navigation module
- Bluetooth® Hands-Free Profile (HFP)
- Bose® Surround Sound System
- HD Radio receiver
- SiriusXM® Satellite Radio receiver
- 19-inch Panamera Turbo II wheels
- Bi-Xenon™ headlights including Porsche Dynamic Light System (PDLS)
- Porsche Entry & Drive
- ParkAssist (front and rear)
- 14-way power seats with memory package
- Seat heating (front and rear)

- Leather interior package
- Dark Walnut interior package

Technical Data

- 4.8-liter, twin-turbo V8 engine
- 520 horsepower
- 0–60 mph in 3.9 secs
- 189-mph top track speed

You can feel it when you're behind the wheel of a Panamera: a focus on performance that never wavers, despite the conflicting demands for comfort and efficiency. It is precisely because our engineering principles remain intact that you can experience the pure pleasure of driving.



Pleasure and principle. Performance.



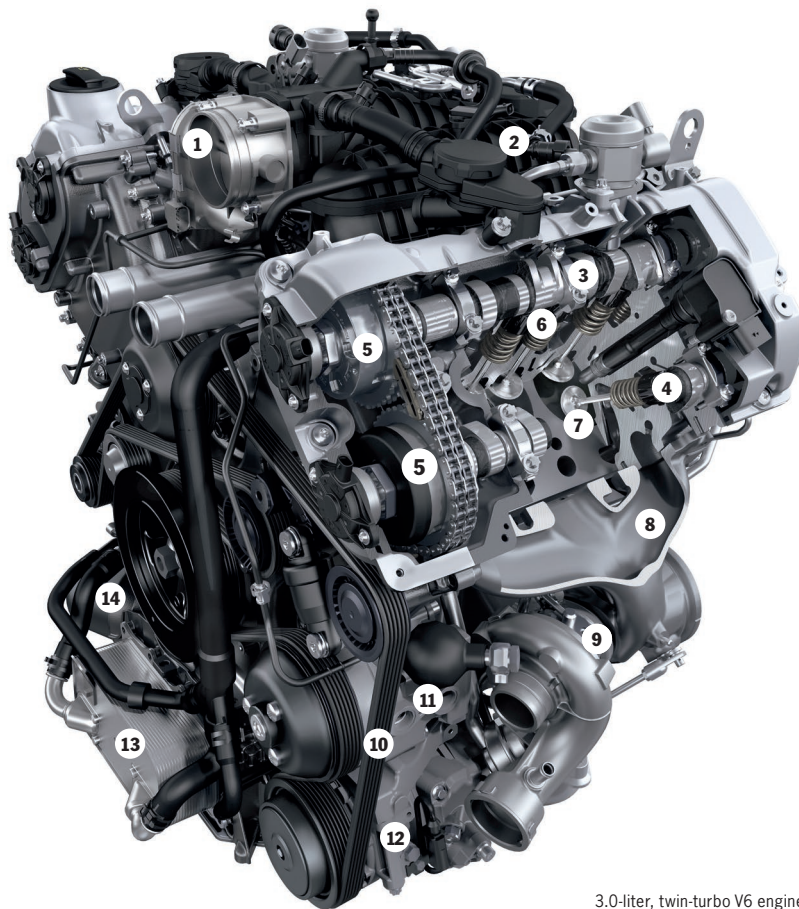

1. Throttle bodies/electronic throttle
2. Intake manifold
3. Intake camshaft
4. Exhaust camshaft
5. VarioCam Plus (valve adjuster)
6. VarioCam Plus (switching tappet)
7. Valve
8. Exhaust manifold
9. Turbocharger
10. Poly V-belts
11. PDCC power-steering pump*
12. Air-conditioning compressor
13. Oil/water heat exchanger
14. Oil filter

3.0-liter, twin-turbo V6 engine

*PDCC pump is optional.

To make things move faster, make them lighter.

Drive.

Engines

The enemy of performance and efficiency is weight. To make the Panamera a sports sedan with the reflexes and responsiveness of a Porsche, we start with engines that are as compact and lightweight as possible, without sacrificing either power or stamina.

This has been achieved in the new engine generation of the Panamera S and Panamera 4S. Compared with the engines in their predecessors, they have been reduced by two cylinders and 1.8 liters of displacement. Remarkably, the reduction in size comes with an increase

in power. Thanks to technologies such as Direct Fuel Injection (DFI), VarioCam Plus or variable camshaft control, and twin turbochargers, the new Panamera S and Panamera 4S offer increased power output—and thanks to the engine's lighter weight, an improved power-to-weight ratio for greater dynamics and enhanced efficiency. Aluminum cylinder heads and magnesium valve covers (except in the Panamera S E-Hybrid) save weight and allow the Panamera to benefit from a more balanced front-to-rear weight distribution—a critical factor in the handling dynamics of a sports car.

The engineering brief to increase power while reducing fuel consumption was fulfilled by other technologies as well: recuperation, the Auto Start Stop system, the coasting function, or the use of plug-in hybrid technology. And the new Panamera S and Panamera 4S engines are durable, thanks to a structurally rigid design that allows for impressive power within such compact displacement.

Direct Fuel Injection (DFI)

DFI injects fuel directly into the combustion chamber. By means of electromagnetically actuated injection valves, fuel is injected at up to 1,740 psi with millisecond precision. Having the mixture prepared directly in the cylinder improves the internal cooling of the combustion chamber, and thus enhances performance. DFI also enables the engine to operate at a higher compression ratio to help deliver more output at the same time as enhanced engine efficiency.

VarioCam Plus

How is a Panamera able to produce instant acceleration and extremely smooth running as well as extraordinary power with comparatively low fuel consumption? One key reason is VarioCam Plus. A two-in-one engine concept for adjusting the intake and

exhaust camshafts and switching the lift of the intake valves, VarioCam Plus differentiates between driver inputs that typify normal, everyday driving and those inputs that demand maximum power. Valve operation is then adapted automatically to prevailing conditions.

Standard in all Panamera models (except the Panamera S E-Hybrid).

Variable Camshaft Control

In the V6 combustion engine of the new Panamera S E-Hybrid, fully variable camshaft control is used to adjust the intake camshaft timing. The result is high specific output and high torque—even at low engine speeds.

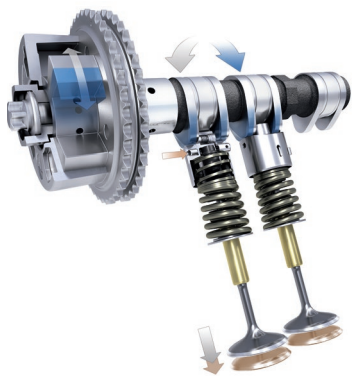

VarioCam Plus

Auto Start Stop Function

The fuel-saving Auto Start Stop system works like this: As soon as you come to a halt and keep your foot on the brake pedal, the system will automatically stop the engine, and restart the engine the moment you release the brakes.

What's new, however, is that the Auto Start Stop function now switches the engine off as you approach traffic lights. All audio and communication systems remain switched on and the climate control continues to maintain your selected temperature, despite the engine being switched off. The engine restarts automatically if the energy needs of the auxiliary equipment can no longer be met by the energy saved in the battery. In all models (except the Panamera S E-Hybrid), the Auto Start Stop function can be activated and deactivated using a separate button.

Coasting

Another fuel-saving technology is the coasting function available with Porsche Doppelkupplung (PDK). It enables you to save even more fuel when the situation allows.* The engine is decoupled from the transmission to prevent deceleration caused by engine braking. The Panamera S E-Hybrid goes one step further and switches off the engine completely. In this way, optimal use is made of the Panamera model's momentum, allowing it to coast for longer distances. This achieves a noticeable reduction in fuel consumption with no impact on comfort or sporty performance.

*Not for Panamera GTS.





Panamera 4S with Sport exhaust system

Lightweight Exhaust System

The exhaust system in the Panamera models is made from long-life stainless steel. The primary and main catalytic converters heat up rapidly and help to deliver effective emissions control. At high engine speeds and under maximum engine load, the exhaust system of the Panamera Turbo opens flaps for increased throughput and an even more thunderous sound.

Sport Exhaust System

Standard on the Panamera GTS and available as an option for the Panamera S, Panamera 4S, and Panamera Turbo, the Sport exhaust system features unique-design tailpipe trims. At the push of a button, the system produces an even more pronounced Porsche sound.

The tailpipes of the Panamera GTS Sport exhaust system have a matte black-painted finish. At the touch of a button or when Sport or Sport Plus mode is enabled, the Sport exhaust system provides that characteristic motorsport sound—another unmistakable expression of the individuality of the Panamera GTS.



Panamera and Panamera 4 tailpipe



Panamera Turbo tailpipes

Who doesn't enjoy a seamless transition of power?

Transmission.

Porsche Doppelkupplung (PDK)

Offering both a manual gearshift and an automatic mode, 7-speed PDK delivers sports performance. You experience rapid gear changes with no discernible interruption in the flow of power. At the same time, it's providing you with exceptional efficiency and comfort as well.

PDK is essentially two gearboxes in one. The double clutch provides an alternating, friction-locked connection between the two half gearboxes and the engine. Gears 1 to 6 have a sport ratio and top speed is reached in 6th gear. The 7th gear has a long ratio, which helps to

keep the engine speed low, even at high speeds. Depending on the gearshift program (Sport button activated or deactivated), the gear change is optimized for comfort or sporty driving.

For the Panamera GTS, we've made PDK even sportier. The gearshift program (Normal, Sport, or Sport Plus) configures the gear changes to be from sporty to extremely sporty. During an upshift, for example, selected engine cylinders are deactivated temporarily, which enables the speed of the engine to be synchronized with the speed of the transmission more quickly. This results in even

faster shift times, accompanied by a characteristic motorsport engine sound.

8-Speed Tiptronic S

The 8-speed Tiptronic S in the Panamera S E-Hybrid reduces fuel consumption and improves comfort. How? With a particularly wide gear ratio spread. The relatively low engine speeds in the upper gears reduce noise levels in the interior, especially on the highway. The 8-speed Tiptronic S shifts automatically and adapts to your driving style. Of course, you can still change gear manually with the gear selector itself or by using the two ergonomic gearshift switches on the steering wheel.





Multifunction steering wheel, Sport Chrono Package



PDK gear selector

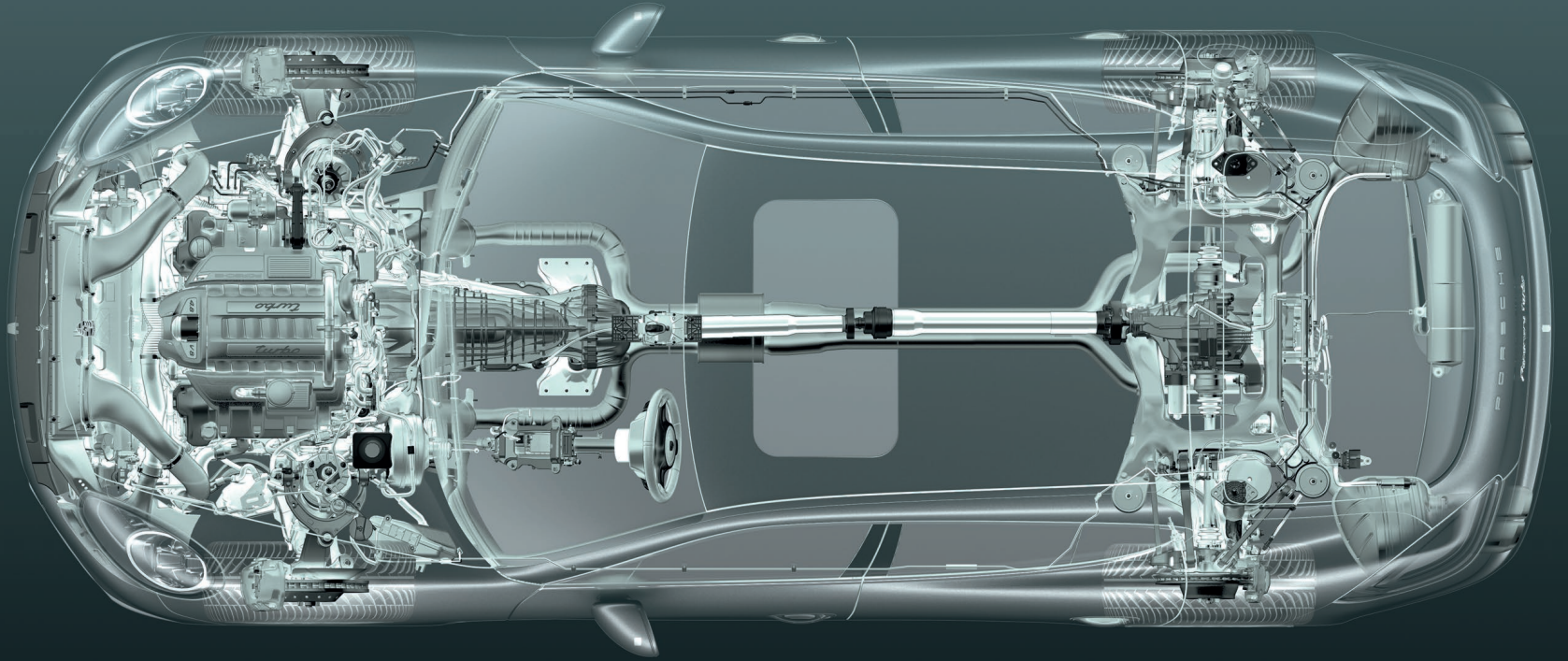

**It manages traction like a good manager should.
By exerting authority. Letting go. Providing balance.**

Chassis.

Porsche Traction Management (PTM)

In conjunction with the upgraded version of Porsche Stability Management (PSM), Porsche Traction Management (PTM) ensures optimal force delivery in every driving situation and excellent acceleration power: whether on long straights, through tight corners, or on road surfaces with varying grip.

PTM comprises an active all-wheel drive with electronic and map-controlled multiplate clutch, with Automatic Brake Differential (ABD) and Anti-Slip Regulation (ASR).

The electronically controlled multiplate clutch regulates the distribution of drive force between the permanently driven rear axle and the front axle. Through continuous monitoring of the driving

conditions, the electronics are able to respond to a variety of situations. Sensors check, among other variables, the rotational speeds of all four wheels, longitudinal and lateral acceleration of the vehicle, and the steering angle.

If, for example, the rear wheels spin under acceleration, a greater proportion of drive force is redirected to the front by a more powerful engagement of

the multiplate clutch. In addition, ASR reduces wheel slip. In corners, the drive force sent to the front wheels is regulated for optimal lateral stability.

Standard in the Panamera 4, Panamera 4S, Panamera GTS, and Panamera Turbo.

**No, we haven't reinvented the wheel.
Just practically everything that goes with it.**

Steering and Power Steering Plus

Power Steering Plus is standard in the Panamera S E-Hybrid and optional for all other Panamera models. With its variable-steering ratio, the system is precise and direct. Around the straight-ahead position, such as when on the highway, the ratio is less direct with no loss of agility or feedback from the road. When the steering wheel is turned further, the steering ratio becomes more direct, allowing easier cornering and parking. At high speeds, the firmer steering ratio enables precision steering maneuvers;

at low speeds, the ratio automatically adjusts to facilitate parking.

Steering Wheels

The multifunction steering wheel is standard in all Panamera models and available on request for the Panamera GTS at no extra cost. It features two ergonomic gearshift switches for manual gear selection and offers convenient control of audio, telephone, and navigation functions as well as the onboard computer. In conjunction with PDK and the Sport Chrono Package, you will find an

additional display above the airbag module for the Sport and Sport Plus modes and the Launch Control function.

The SportDesign steering wheel with gearshift paddles is standard in the Panamera GTS and available as an option for all other models. It is distinguished by its striking dual-arm design. Upon request, it is possible to have the SportDesign steering wheel finished in black Alcantara®.



SportDesign steering wheel, Sport Chrono Package



Multifunction steering wheel





19-inch Panamera Turbo II wheel



18-inch Panamera wheel



18-inch Panamera S wheel

Wheels and Tire Pressure Monitoring System (TPMS)

The wheels on all models are lightweight alloys featuring a classic sporty design. The Panamera and Panamera 4 come standard with 18-inch Panamera wheels. The Panamera S, 4S, and Panamera S E-Hybrid are fitted with 18-inch Panamera S wheels. All of the 18-inch wheels are fitted with summer/performance tires. Tire sizes 245/50 ZR 18 and 275/45 ZR 18 are fitted to the front and rear, respectively. The Panamera GTS and Panamera Turbo come standard with 19-inch Panamera Turbo II wheels with all-

season tires. Summer performance tires are available as an option. The tire sizes are 255/45 R 19 at the front, 285/40 R 19 at the rear. A range of optional 19- and 20-inch wheels fitted with summer performance tires is available. In addition, all-season tires are optionally available for all 20-inch wheels.

Tire Pressure Monitoring System (TPMS) sends warnings to the onboard computer's display screen in the event of excessive pressure loss.

TPMS is standard in all Panamera models.

How to have a more intimate relationship. With the road.

Porsche Active Suspension Management (PASM)

PASM is an electronic damping-control system that actively and continuously adjusts the damping force on each wheel, based on road conditions and driving style. This reduces body movement and increases comfort in all four seats.

How does PASM work? By means of a button on the center console, you can select one of the three modes: Comfort, Normal, or Sport. Sensors record the body movements that

accompany powerful acceleration, braking, and rapid cornering or uneven road surfaces. The control unit evaluates the driving conditions and modifies the damping force on each of the wheels in accordance with the selected mode. You can feel the result: increased driving stability, more comfort, and improved performance.

Optional for the Panamera and Panamera 4, standard in all other models.

Adaptive Air Suspension

Adaptive Air Suspension enhances both driving dynamics and comfort at the same time. It comprises a leveling system, a manual lift function, ride-height adjustment capability, and the ability to vary the spring rate.

The purpose of the leveling system is to keep the vehicle level constant automatically, regardless of load distribution. For maneuvering, the manual lift function enables you to raise the vehicle body by 20 mm to avoid the risk of grounding.

When you select the Sport Plus chassis program, the ride height drops to Low Level (–25 mm, or –15 mm in the Panamera GTS). At the same time, a harder spring rate is achieved through a reduction in the amount of air stored in the Air Suspension. In simple terms, at the push of a button, it transforms the behavior of the chassis to favor sporty performance.

Standard for the Panamera S E-Hybrid, Panamera GTS, and Panamera Turbo; optional for all other models.



Rapid cornering without PDCC (illustrative example)



Rapid cornering with PDCC (illustrative example)



**If you want to stay glued to the road,
you've got to have the right adhesives.**

Porsche Dynamic Chassis Control (PDCC) Including Porsche Torque Vectoring Plus (PTV Plus)

Porsche Dynamic Chassis Control (PDCC) is an active anti-roll system that anticipates and reduces lateral body movement during cornering maneuvers. In addition, it minimizes the lateral instability of the vehicle on uneven ground.

PTV Plus—in combination with PDCC—enhances driving dynamics as well as stability. As a function of steering angle

and steering speed, accelerator pedal position, yaw rate, and vehicle speed, it is able to improve steering response and steering precision by specific braking of the right or left rear wheel.

What do PDCC and PTV Plus mean for you? Remarkable lateral stability and easier handling, excellent traction, and great agility at every speed, with precise steering and stable load transfer characteristics. And even more fun in the corners.

Optional for all Panamera models, but not available for the Panamera S E-Hybrid.

Porsche Stability Management (PSM)

PSM helps to maintain stability even at the limits of dynamic driving performance. Sensors continuously monitor the direction, speed, yaw velocity, and lateral acceleration of the car. PSM improves traction under acceleration on inconsistent road surfaces. When Sport Plus mode is selected on the Sport Chrono Package, the PSM intervention threshold is raised to give drivers greater range to assert a sportier driving style.

Standard in all Panamera models.

Desire ultra-high performance? With Panamera, just push a button.

Performance enhancement systems.

Sport Button

All Panamera models come standard with a Sport button. It enables you to select a setup that favors either comfort or sporty performance. At the push of a button, the electronic engine management system switches the engine mapping to offer a sharper response and engine dynamics that are more direct.

With the gearbox in automatic mode, upshifts take place at higher engine speeds, and downshifts are swifter. Depending on how equipped, the optional Porsche Active Suspension Management

(PASM) and the optional Porsche Dynamic Chassis Control (PDCC) also switch to Sport mode to deliver harder damping and more direct steering and, therefore, even more agile cornering.

Sport Chrono Package

The Sport Chrono Package helps to provide an even sportier setup. Included in the package are a digital and analog stopwatch, the Sport Plus button, the longitudinal and lateral acceleration display, and a performance display in PCM for displaying lap times.

The Sport Plus button on the center console is used to activate Sport Plus mode. The engine becomes even more responsive. The rev limiter is adjusted to a harder setting (except in the Panamera S E-Hybrid). Vehicles with Porsche Active Suspension Management (PASM) switch to Sport Plus mode for harder damping and more direct steering. Models with Adaptive Air Suspension drop to Low Level and switch to a stiffer spring rate. In Sport Plus mode, the trigger threshold for PSM is raised for increased longitudinal and lateral dynamics.

The stopwatch mounted on the dashboard displays recorded driving time or can be used as a conventional clock. Porsche Communication Management (PCM) has a special performance display to view, store, and evaluate lap times or other driving times.

When combined with PDK, the Sport Chrono Package has two additional functions: The shift times in Sport Plus mode become even shorter, the gear changes even sportier. The second function is Launch

Control, designed to produce optimal acceleration from a standing start.

For the Panamera Turbo, the Sport Chrono Package takes performance to another level entirely. With the overboost function, whenever you accelerate at full throttle in Sport or Sport Plus mode, the turbocharger's boost pressure will be increased temporarily by up to 10 percent. This significantly increases the maximum torque, delivers a short-term complacent 516–568 lb.-ft.—and puts a smile on the driver's face.

Standard in the Panamera GTS, optional for all other Panamera models.



Sport button on the center console



Digital and analog stopwatch on the dashboard





Calm and pulse. Balance.

Driving a Porsche is a balance between two emotions: a pulse-quicken energy fueling the car's response to your right foot, and an inner calm that comes from the confidence of knowing you have some of the world's most advanced technologies aiding your every move.



Night light design of the Bi-Xenon™ headlights



Night light design

**The more you can see, the more you know.
And knowledge is power.**

Lighting.

Lighting Concept

Run as many 12- and 24-hour endurance races as Porsche has, and you realize the critical role lighting plays in fulfilling the performance potential of both car and driver. That's why Bi-Xenon™ headlights are standard on all new Panamera models. Featuring automatic and dynamic range adjustment, a headlight-cleaning system, and integral daytime running lights with four LED spotlights in each headlight, these are no ordinary headlights. On the new Panamera GTS, the Bi-Xenon™ headlights are finished in black.

Even more advanced is the Porsche Dynamic Light System (PDLS). Standard on the Panamera Turbo, Panamera GTS, S, 4S, and S E-Hybrid, and optional for the Panamera and Panamera 4. PDLS employs a dynamic cornering light function. Based on the steering angle and driving speed, it swivels the headlights toward the inside of the corner. The static cornering lights activate the auxiliary headlights in order to illuminate more of the road in tight curves and turns.

Automatic headlight activation is standard on all models, switching the lights on automatically when it gets dark. The lighting system also includes an automatic switch-off feature and the "Welcome Home" function—a customizable delayed switch-off timer that keeps the daytime running lights and the taillights switched on until you reach your front door.

LED brake lights are also standard.

**LED Headlights Including
Porsche Dynamic Light
System Plus (PDLS Plus)**

A new development is available on request for every Panamera model: LED headlights including Porsche Dynamic Light System Plus (PDLS Plus). The inner workings of each headlight comprise two light units in a stacked arrangement—a design feature that reinforces the imposing appearance of the new Panamera models.

The LED beam is remarkably powerful and provides excellent illumination of the road. Thanks to the optimal balance between short- and long-distance lighting with side illumination, the similarity in color with the daytime running lights, and low light scatter, the driver's eyes have less fatigue than with other systems.

The Porsche Dynamic Light System Plus (PDLS Plus) has been combined with the LED main headlights. Not only does PDLS Plus offer all the functions of PDLS—it also features a dynamic main beam.

The dynamic main beam is activated from a speed of 40 mph and detects vehicles driving in front as well as oncoming traffic.



Daytime running lights of the LED headlights

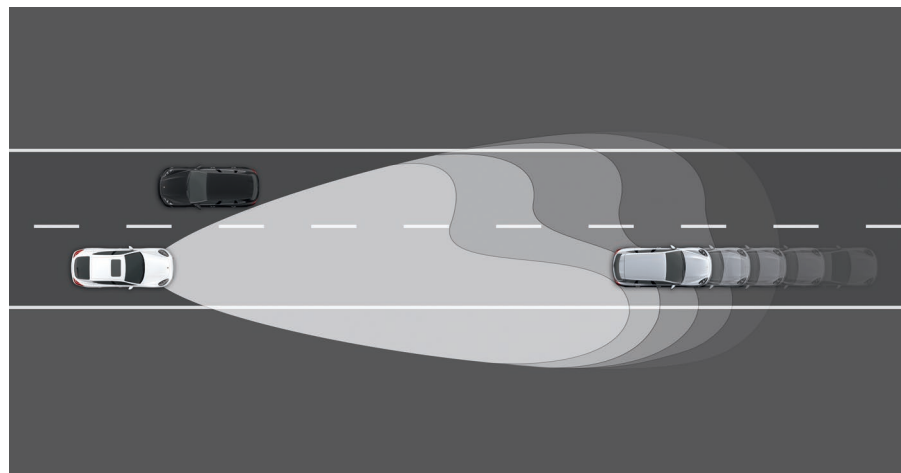

Porsche Dynamic Light System Plus (PDLS Plus)



Night light design of the LED headlights



LED headlights



Panamera 4S with Porsche Ceramic Composite Brakes (PCCB)

Sometimes the power to stop is the most rewarding power of all.

Safety.

Brakes

It's always been the belief of Porsche that our cars should be able to shed speed as fast as they can accumulate it. Which is why the new Panamera models have a braking system equipped with 6-piston, aluminum monobloc fixed calipers at the front and 4-piston units at the rear. The brake calipers on the Panamera and Panamera 4 are finished in black; on the Panamera S models, they are silver-colored; on the Panamera S E-Hybrid, they are Acid Green; and on the Panamera GTS and Panamera Turbo, they are red.

The brake rotors are slotted and internally vented for enhanced braking

performance—even under extreme conditions—and rapid heat dispersal. The brake rotors on the Panamera Turbo and Panamera GTS have a diameter of 390 mm at the front and 350 mm at the rear. On the other Panamera models, the discs are 360 mm in diameter at the front and 330 mm at the rear.

The electric parking brake, which you can activate and deactivate manually, releases automatically as you pull away. Thanks to the hold function, you can pull away without ever rolling back.

Porsche Ceramic Composite Brakes (PCCB)

On request, your Panamera can be fitted with a braking system that has proven itself on the racetrack: the Porsche Ceramic Composite Brakes (PCCB). The cross-drilled ceramic brake rotors on the Panamera Turbo and Panamera GTS have a diameter of 410 mm at the front and 350 mm at the rear; the other models feature discs with a diameter of 390 and 350 mm at the front and rear, respectively.

PCCB is characterized by its low thermal expansion under heavy braking, which helps to prevent deformation, and

resistance to corrosion while offering better noise-damping properties.

The key advantage of PCCB is the extremely low weight of the brake discs, which are approximately 50 percent lighter than standard discs of similar design and size. Although enhanced performance and fuel economy are benefits, it also represents a major reduction in unsprung and rotating masses. That means better handling, better roadholding, and increased comfort, particularly on uneven roads.

Optional for the Panamera Turbo and GTS with 20-inch wheels; for other Panamera models with 19-inch wheels or larger.

Engineered Body Design

The Panamera bodyshell is constructed from super high-strength metals, stainless steel, magnesium, and aluminum. This ensures a low overall weight, and also produces a highly resilient passenger cell that offers high levels of protection in the event of an impact. The system of longitudinal and transverse members at the front absorbs deformation energy and disperses the forces, thereby minimizing deformation of the interior. In addition, passive safety is further enhanced by the aluminum front-axle subframe, which is designed to deform

in a defined manner. A rigid bulkhead crossmember reduces deformation of the footwell in the event of an impact and provides improved protection for the feet and legs. In a minor collision, a system of easily replaceable impact absorbers prevents costly damage to the underlying bodyshell.

Airbags and Seat-Belt System

All Panamera models come standard with full-size driver and front-passenger airbags. Depending on the severity and type of accident, they are inflated in two stages. In less serious accidents, the airbags are only

partially inflated, thereby minimizing discomfort to the occupants.

As well as knee airbags for driver and front passenger, the Porsche Side Impact Protection (POSIP) system is also standard.

POSIP comprises side airbags in the front seats, curtain airbags along the entire roof frame and the side windows from the A-pillar to the C-pillar, and side-impact protection elements in the doors. Side airbags in the rear compartment are available as an option. Also standard are an energy-

absorbing steering column, 3-point seat belts on all seats, belt height adjustment and seat-belt force limiters in the front, and seat-belt pretensioners front and rear. A rollover sensor automatically activates the curtain airbags and seat-belt pretensioners if the vehicle threatens to overturn.





Panamera with 19-inch Panamera Classic wheels, Panamera S E-Hybrid with 20-inch Panamera Sport wheels

**There is only one place we like to leave a lasting mark:
in a person's heart.**

Porsche and the environment.

Environmental Protection

Electromobility is the topic of the day. After all, we are all searching for answers to one of the greatest challenges of our time: how to conserve resources. How can we reduce energy requirements and CO₂ emissions? Our answer is e-mobility. In other words, sustainable mobility. Our solution is the Panamera S E-Hybrid. Here, we substitute oil for regenerative electricity and combine high performance with excellent everyday practicality.

With hybrid technology, we are exploring new directions without losing sight of familiar ground: Porsche has managed

to increase fuel efficiency in all of the current models compared with the respective previous models. This is made possible by an efficient drive concept, lightweight construction, optimized aerodynamics, and low rolling resistance.

Vehicles manufactured by Porsche prove that even high-performance sports cars can achieve comparatively moderate exhaust emissions values in their respective category. This high level of environmental responsibility is clearly demonstrated by our approach to environmental management at the Porsche Development Center in Weissach. Here, all technological

developments are carried out with environmental protection in mind.

Lightweight Construction and Recycling

Intelligent lightweight construction has been integral to the Porsche identity since the very beginning. So it's expected for Porsche engineers to pursue ever lower fuel consumption while achieving outstanding performance.

It is also ecological, because all materials used are meticulously selected to ensure we use only innovative and environmentally friendly components. All of the lightweight materials we use are easily recyclable and each material

is labeled to facilitate its separation for recycling. The reduction in the number of plastic variants helps to ensure more efficient recycling. Recycled plastics are used when they meet our exacting technical requirements. As a result, the Panamera models are approximately 95 percent recyclable.





Style and feel. Personality.

When style is a pure expression of individuality, of one's own ideas and impulses, it lends self-assurance to every action and every encounter. It's only by remaining true to those desires that style becomes your own personal style.

The Panamera passenger cabin. Surround yourself with personal space. Even when you're on the move.

Interior.

Your first impression of the Panamera interior is the generous amount of comfort. The second impression is one of attention to detail and precise ergonomics. The five round instruments have an integrated 4.8-inch color screen. The center console ascends toward the front, shortening the reach between the steering wheel and the gear selector. All of the important controls are arranged into logical groups to give you quick access to important functions, without the need to scroll through long sub-menus.

Smooth-Finish Leather, Natural Leather, two-tone color combinations, elegant Woods, Aluminum, and Carbon Fiber—thanks to these and many more personalization options, you can make your Panamera sportier, more comfortable, or a unique blend of both. In the Panamera Turbo and Panamera GTS, the roof liner is upholstered in Alcantara® (optional for all other models).

The Panamera models offer a variety of storage options—in the doors and center console, for example. There is a cupholder in the front center armrest and two foldout cupholders in the rear compartment.

For extra storage space, a large center console is available as an option for the rear compartment. It comes with a 120-volt socket, an additional 12-volt socket, and preparation for a mini-refrigerator. The interior lighting concept

includes illuminated door handles and storage compartments in the front, orientation lights, front footwell lights, as well as reading lights and interior lights—one of each for all four seats. A switch-off delay feature makes the lighting practical and appealing.



Interior of the Panamera S E-Hybrid in Marsala, Brushed Aluminum interior package



Interior lighting package for rear compartment

Want an even more illuminating experience? An optional interior lighting package conceived specifically for the rear adds two reading lights to the overhead console, lights in each footwell, additional orientation lighting in the rear, and illumination for door storage compartments and the compartment

in the rear center console. These are predominantly powerful yet energy-efficient LEDs. There is additional ambient lighting on the overhead consoles in the front and rear, and the reading lights are dimmable.

2-zone automatic climate control, with zonal regulation in the front compartment, is integrated as standard. An active carbon-fiber filter traps particles, pollen, and odors. 4-zone automatic climate control, with separate temperature controls for all four seats, is available as an option.

Thermally and noise-insulated glass can be fitted as an option. The electric roll-up sunblinds in the rear compartment and on the rear side windows are also available as an option.

Optional soft-close doors are available for all Panamera models. A closing mechanism integrated in each door lock ensures comfortable and safe closing of all four doors.



4-zone automatic climate control

Front Seats

The front seats with integrated headrests offer a high degree of comfort and hold your body firm during cornering, without restricting your freedom of movement. Standard power seats for the driver and front passenger adjust for seat height, seat cushion and backrest angle, and fore/aft position. A driver memory package, available as an option, enables the driver seat and exterior mirror positions to be saved and restored automatically.

14-Way Power Seats

Optional 14-way power seats with memory package (standard in the Panamera Turbo) for driver and front passenger offer even more functionality. In addition to power steering-column adjustment, the memory package includes power 4-way lumbar support, power seat cushion length adjustment, and personal memory settings for seat, steering wheel, PCM, and mirror positions.

The courtesy lights (LEDs in the exterior mirrors) are a component of the driver memory package and 14-way power seats with memory package.

Adaptive Sport Seats

Standard on the Panamera GTS and optional on the other models, the 18-way Adaptive Sport Seats have firmer—yet still comfortable—upholstery and provide even better lateral support, thanks to the raised side bolsters on the seat cushion and backrest.

With 18-way power adjustment, the Adaptive Sport Seats can be adapted to meet your precise needs for seat height, seat cushion and backrest angle, seat cushion length, fore/aft adjustment, and 4-way lumbar support. The steering column is power-adjustable, and the side bolsters on

the seat cushion and backrest are independently adjustable for added comfort over long distances or precision lateral support on winding roads. Also included is the personal memory for the driver and front-passenger seats (including lumbar support), the steering wheel, and the driver exterior mirror.



Standard front seat



Adaptive Sport Seat



Rear Seats

The rear compartment has two fully independent seats with plenty of legroom and headroom, even for taller passengers. Without compromising comfort, they provide exceptional lateral support, even during fast cornering. Between the seats is a folding armrest with a handy storage compartment. The backrests fold down individually with a ratio of 40:60 to increase storage capacity or to accommodate larger items. The split is 40:20:40 in conjunction with the optional ski bag. With the optional large center console, the backrests can still be folded separately while the console itself remains fixed in position.

8-way power seats (rear) (in conjunction with large center console) with comfort headrests

8-way power seats are available as an option for the rear in any of the Panamera models. In addition to the power adjustment of the backrest, seat cushion length, and lumbar support functions, you can adjust the front-passenger seat from the rear. When specified in conjunction with seat ventilation, the 8-way power seats (rear) feature automatic comfort headrests. In conjunction with the 18-way Adaptive Sport Seats in the

front, Sport seats are also fitted in the rear and feature a sporty seam design and elevated side bolsters.

LATCH child seat-mounting points are fitted as standard on both rear seats in all Panamera models.

Seat Heating and Ventilation

The front seats of all the Panamera models feature seat heating as standard. This heats the seat cushion and backrest to a pleasant temperature. In the Panamera Turbo, the seats in the rear also have a heating function (optional for all other models). On request, we can equip the front seats, indeed all four seats, with seat ventilation (only in conjunction with seat heating). A slipstream effect is produced by active ventilation of the perforated seat center and backrest and by passive aeration at the side bolsters. This evaporates perspiration moisture and therefore makes for a comfortable seating environment, even in hot weather. Seat heating and seat ventilation can be adjusted independently to any one of three power levels.



Rear seats

Intelligent Performance. It even applies to how we integrate technology into the interior.

Communication and audio.

Porsche Communication Management (PCM) with Navigation Module

To provide a central source where you can intuitively control advanced audio, navigation, and communication functions, we provide the Porsche Communication Management (PCM). Powerful and multifunctional, its ease of use starts with the 7-inch high-resolution touchscreen with graphical user interface. You can also operate PCM using separate rotary push-button controls. The radio has an FM twin tuner, while the DVD audio drive plays CDs and audio DVDs and is MP3-compatible. A 6-disc CD/DVD changer integrated in PCM is available as an option. The universal audio interface (USB) allows

you to store and play up to 5,000 MP3 files on the 40GB internal hard drive.

In conjunction with PCM, a total output of 235 watts is produced through a combination of 11 loudspeakers. In the Panamera Turbo, the Bose® Surround Sound System is fitted as standard and features 14 loudspeakers delivering a total output of 585 watts. For an even greater sound experience, PCM can be combined with the optional Burmester® High-End Surround Sound System to offer over 1,000 watts produced by 16 direct-drive loudspeakers (not for the Panamera S E-Hybrid).

A navigation module with high-speed hard drive is included with PCM. For route guidance, it is possible to select between a 2-D display and a 3-D perspective. In some regions, even buildings can be shown in 3-D, as can the terrain, the latter superimposed with a satellite map image. Split-screen mode enables you to view two functions at once, such as the current navigation map and list of symbols that represent your next driving instructions.

One key function of PCM in the Panamera S E-Hybrid is the graphical display of the hybrid drive system showing the flow of energy in the various modes, such as all-electric

mode, e-boost, recuperation, or coasting. Another display—Hybrid Zero Emission—shows you the amount of time, as a proportion of the total driving time, that you have spent driving without the combustion engine.



Porsche Communication Management (PCM)

Universal Audio Interface

Your PCM has standard a connectivity package: an AUX interface and a USB port for connecting your iPod® or iPhone®. Your iPod®, iPhone®, compatible MP3 player, or a USB stick connected to the USB interface can be controlled using PCM. Through the USB port, it is possible to transfer up to 5,000 tracks in MP3 format to the 40GB internal hard drive of PCM, where they can be accessed for direct playback. Playback of recognized podcast and audiobook formats is supported and cover art is displayed.

SiriusXM® Satellite Radio Receiver*

Standard on the Panamera Turbo and available as an option on all of the other Panamera models, the SiriusXM® Satellite Radio receiver includes a three-month free trial period. This service provides over 130 channels coast to coast, including commercial-free music, plus the best sports, news, talk, comedy, and entertainment. With SiriusXM®, you can even get sports and market updates customized on your favorite teams and stock listings, so you can arrive at your destination well-informed.

The optional NavTraffic® service, available with SiriusXM®, helps you avoid congestion before you reach it with information on traffic speed, accidents, construction, and road closings. NavTraffic® enables the PCM to display continuously updated traffic information in over 130 markets.

The optional NavWeather® service, available with SiriusXM®, allows you to stay informed with weather information on the PCM screen. In a driver-friendly format, it's easy to see storms and severe weather in your area, keep track of weather warnings, and see the current conditions and 3-day forecasts.

*SiriusXM® Radio requires a subscription, sold separately after any trial included with vehicle purchase or lease. **If you decide to continue your SiriusXM® service at the end of your subscription, service will automatically renew and bill until you call SiriusXM® at 1-866-635-2349 to cancel.** See SiriusXM® Customer Agreement for complete terms at www.siriusxm.com. Satellite service available only to those at least 18 and older in the 48 contiguous United States and D.C. Sirius, XM, and all related marks and logos are trademarks of SiriusXM® Radio Inc.

Voice-Control System

Need directions? Want to make a phone call? Or simply want to change radio stations? Then just say so. The voice-control system for PCM is at your command. Voice control allows the word-by-word input of destination addresses, phonebook entries, or radio station names. You can also scroll through lists by voice control.

Electronic Logbook

An electronic logbook is available for PCM as an option. It automatically logs the mileage, route distance, date, time, starting location, and destination for every journey.

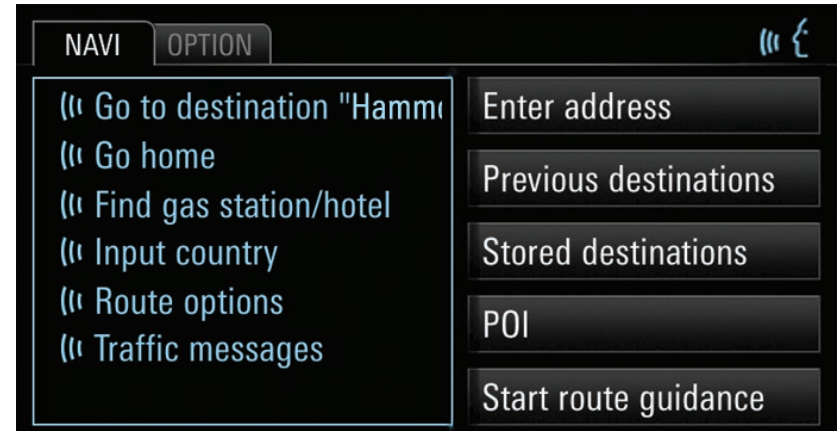

Voice-control system

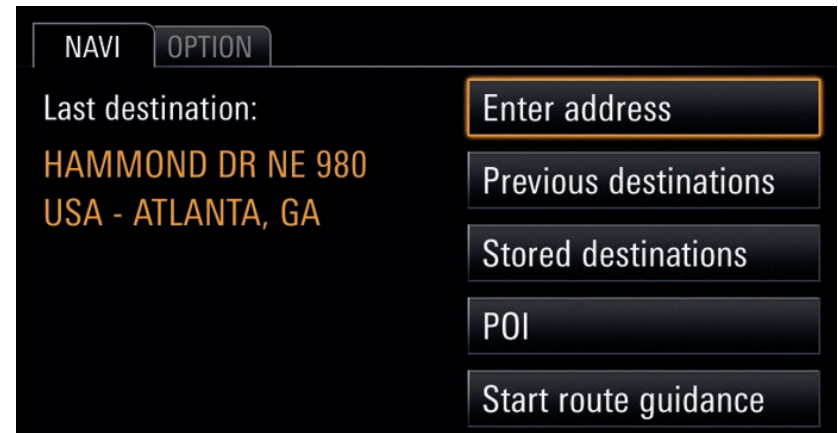

Electronic logbook

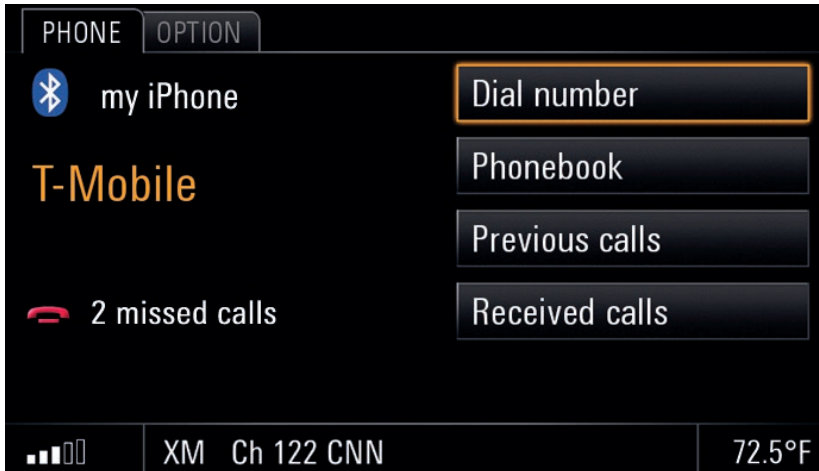

Telephone module

Telephone Module

The quad-band GSM telephone module is available as an option for PCM and offers convenience and excellent reception. With a SIM card inserted directly into the PCM integral SIM card reader, calls can be made using either the hands-free facility or the cordless handset. Alternatively, the Bluetooth® capability of a mobile phone can be used to make calls through the SIM Access Profile (SAP). Once automatic pairing is complete, the mobile phone's antenna is switched off

to conserve battery charge, and the phone operates via the car antenna.

Depending on the type of mobile phone, this gives access not only to the numbers on the SIM card, but also to the phone's internal memory. Depending on the phone, it can be controlled using PCM, the multifunction steering wheel, or the voice-control system, without it ever leaving your pocket. In addition, the telephone module enables you to establish a Bluetooth® link with those mobile phones that only support the Hands-Free Profile (HFP).

In this case, the GSM connection is always established through the antenna of the mobile phone. PCM acts as a hands-free system and you can leave the mobile phone tucked away.

To make a private call even with other passengers in the vehicle, the telephone module includes a cordless Bluetooth® handset along with a display and keyboard located in the center console. (The handset cannot be used for Bluetooth® links established using the Hands-Free Profile (HFP) feature.)

Mobile Phone Preparation

A standard mobile phone preparation enables a Bluetooth® connection for those mobile phones that only support the Hands-Free Profile (HFP). This function also enables you to leave your mobile phone tucked away. The PCM can be used to control only the basic functions of the mobile phone, and the GSM connection is established through the mobile phone.

Online Services

With the optional Online Services, download the free Aha® Radio app

to use your smartphone to stream Internet radio, news feeds, podcasts, and audiobooks directly to the PCM. Local information, such as hotel and restaurant listings, can be read aloud automatically, thanks to text-to-speech functionality. Points of Interest searches with subsequent direct selection as your navigation destination are also supported. The online content is received by your smartphone and controlled by means of PCM.

Porsche Rear Seat Entertainment

Porsche Rear Seat Entertainment is available as a factory-fitted option from Porsche Exclusive. The system comprises two display consoles, two multimedia players, and two wireless infrared headphones. It is compatible with all popular media formats (e.g., CD, DVD, MP3) and features user-friendly touchscreens. It is also possible to connect two separate, individually selectable AV sources, such as a game console or digital camera. Each containing a swiveling 7-inch TFT screen, the screen consoles are finished in Leather in the interior color and mounted on the front-seat backrests.



Porsche Rear Seat Entertainment

Audio performance that's powerful and nuanced. Isn't that precisely what you'd expect from a Porsche?

Sound systems.

Bose® Surround Sound System

The optional Bose® Surround Sound System transforms your Panamera into a concert hall. Its 9 amplifier channels, 14 loudspeakers, and 200-watt active subwoofer deliver a balanced acoustic pattern and a total output of 585 watts. (Panamera S E-Hybrid: 160-watt active subwoofer, 545-watt total output.)

In combination with PCM, the Bose® Surround Sound System enables audio playback of DVDs. Of course, you can still play other audio sources such as CDs and MP3s, in stereo, or at the push of a button, in one of the virtual

surround modes generated by Bose® Centerpoint® 2. The patented AudioPilot® Noise Compensation Technology uses a microphone to continuously measure all the noises inside the vehicle and adapts music playback automatically so that a consistent sound is maintained, whatever the driving conditions and in real time.

The result is a balanced, faithfully reproduced sound and a captivating 360-degree acoustic experience delivered to all four seat positions.

Standard on the Panamera Turbo and optional for Panamera, 4, S, 4S, and GTS models

Burmester® High-End Surround Sound System

The distinctive Porsche sound developed at our research center in Weissach is amplified by a sound from Berlin. We're referring to Burmester®, one of the world's most respected audio engineering firms, and the Burmester® High-End Surround Sound System. Available as an option in combination with PCM, the Burmester® High-End Surround Sound System uses technologies from the finest home audio systems that Burmester® has to offer. The countless details of this system have one goal: perfection in sound.

Its 16 amplifier channels produce a total output of more than 1,000 watts and its 16 loudspeakers include an active subwoofer with 300-watt Class D amplifier. The speakers have a total diaphragm surface area of more than 2,400 cm², and a frequency response of 30 Hz to 20 kHz. Crossover technology has been carried over more or less unmodified from the home audio sector. Analog and digital filters have been optimally defined for their installation location and finely tuned after extensive in-car audio testing. Ribbon tweeters have been used for unmistakably fine, clear, and undistorted high-frequency

sound reproduction with excellent level stability. All loudspeaker housings are perfectly matched and deliver superior bass foundation, definition, and impulse accuracy. The result is a natural and richly textured spatial sound, even at top volume. The elegantly pure design with galvanized surrounds and Burmester® logos on selected loudspeakers makes it clear that the appeal of the Burmester® High-End Surround Sound System is as much about the visual as it is the audio. Sound and style without compromise.

Optional for all Panamera models but not available on the Panamera S E-Hybrid.



Making the connection between a sports car and its driver even closer. Digitally.

Assistance systems.

Porsche Car Connect

Porsche Car Connect is an innovative way to deepen the connection between a Panamera and its owner.

A smartphone app, Porsche Car Connect, enables you to access various data relating to your car and control certain functions remotely—any time, any place.

Carfinder displays the shortest route from your current position to the parked location of your Panamera.

Thanks to Remote Vehicle Status, the most important data from your Panamera are always available at a glance. For example, you can check

your fuel level, odometer reading, or whether you've left the windows and doors open or closed.

Remote Services gives you fingertip access to a range of statistics recorded by your car, including distance covered, average speed, and fuel consumed during the last drive.

A particularly practical function of Porsche Car Connect is the ability to make a roadside emergency call from any location. You can also check the status of the alarm system whenever you want to and wherever you are. In addition, you can use your smartphone to control the locking of doors

and windows and the folding of the exterior mirrors (starting 12/2013).

For the Panamera S E-Hybrid, Porsche Car Connect is enhanced with a comprehensive range of e-mobility services tailored specifically to its hybrid power. Features include an overview of the current battery charge state and available all-electric range. You can also control the air conditioning of your car remotely as desired with the optional auxiliary climate control system.

Standard on the Panamera S E-Hybrid and optional for all other Panamera models.



ParkAssist

ParkAssist is standard in all Panamera models. With four sensors in the rear, the system audibly alerts the driver to the presence of obstacles detected behind the vehicle. An intermittent warning tone increases more rapidly as the obstacle is approached. An enhanced version of ParkAssist, which includes six sensors in the front, is standard on the Panamera Turbo and available as an option on the other models. The audible alert is supplemented by a visual warning in the central display screen that provides a graphical representation of the vehicle's proximity to obstacles.

Reversing Camera

The optional reversing camera facilitates precise reverse parking and maneuvering and also assists in hitching a trailer. Help is provided in the form of the camera image and the dynamic, superimposed guidelines on the PCM screen that illustrate the predicted course of the Panamera, given the current position of the steering wheel.

Surround View

Surround View is made possible with four cameras—one in the front fascia and one in each lower trim of the exterior mirrors. Based on the information supplied by all four cameras, the system generates a virtual bird's-eye

view of the car and displays it on the PCM screen. This provides additional assistance to the driver when parking and maneuvering because even low-level obstacles at the front and side of the vehicle can be detected. It is also possible to switch between various camera views to improve visibility, for example at narrow exits.

Cruise Control

For added driver comfort on long stretches of road, cruise control comes standard. Cruise control operates above 20 mph and is selected using a button on the steering-column control stalk.

Adaptive Cruise Control Including Porsche Active Safe (PAS)

Available as an option, this enhanced version of cruise control regulates the speed of your vehicle in line with the speed of the vehicle in front. A radar sensor inside the front end scans the road ahead up to a distance of 650 feet. Imagine you've selected a cruising speed but have begun to gain on the vehicle in front because it is driving more slowly—the system reduces the speed of your vehicle by restricting throttle or gently applying the brakes until your chosen distance from the vehicle in front is maintained. For safety reasons, the driver should always be prepared to intervene manually if heavier braking is required.

If the vehicle ahead slows further, Adaptive Cruise Control will decelerate your Panamera accordingly—even down to a halt. As soon as the road ahead clears, your vehicle will accelerate back up to the cruising speed originally set. To pull away after an automatic stop, simply press the control lever or depress the accelerator pedal. If desired, the driver can enable the integrated Stop & Go function, which automates stopping and pulling away in congested traffic.

Safety is further improved by Porsche Active Safe (PAS). If you are approaching the vehicle in front too quickly, you will be prompted to take the necessary action by an audible and visual warning as well as a jolt of the brakes. The system may also intervene with targeted braking applications and act to boost brake pressure as the situation demands, even to the point of the maximum braking force that the system is able to provide.



Graphical display of ParkAssist (front and rear)



Reversing camera



Adaptive Cruise Control with Porsche Active Safe (PAS) and Lane Departure Warning (LDW)

Lane Change Assist (LCA)

Optional Lane Change Assist (LCA) uses radar sensors to monitor the areas to the rear of your vehicle and the blind spots on either side. Above a speed of 20 mph, the system issues a visual warning signal in the exterior mirrors whenever a vehicle rapidly approaches your vehicle from behind or enters one of your blind spots. This improves comfort and safety, particularly on highways. However, LCA does not actively intervene to control the vehicle and can be deactivated at any time.

Lane Departure Warning (LDW)

A camera inside the rearview mirror casing monitors the road surface in front of the vehicle. If enabled, the system will sound a warning tone whenever you steer toward a divider line marking and threaten to leave the current lane without indicating.

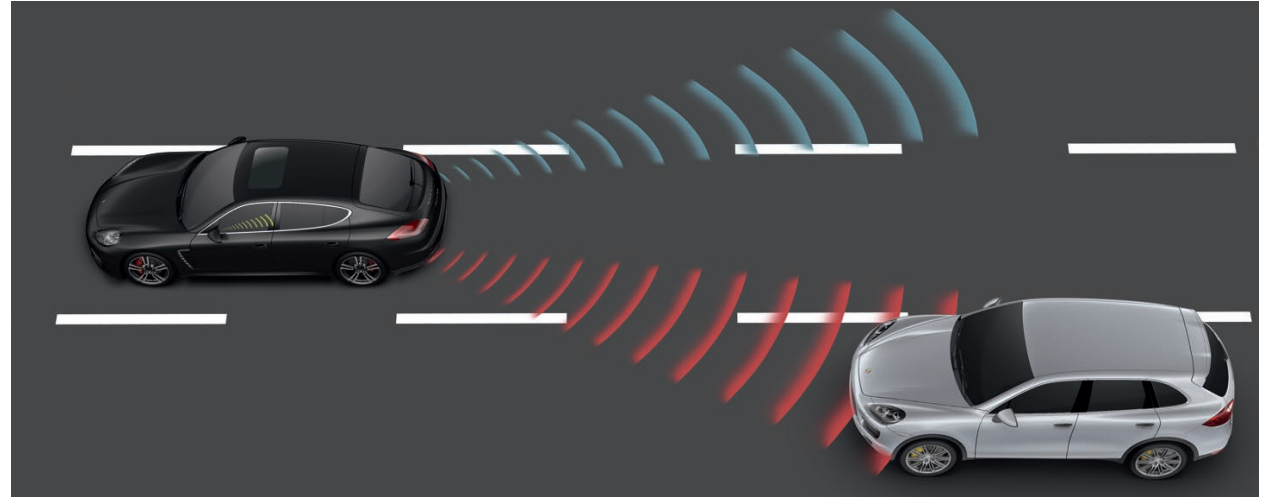

Lane Change Assist (LCA)

Porsche Entry & Drive

Standard in the Panamera Turbo and optional for the other models, Porsche Entry & Drive eliminates fumbling for your keys. As soon as you touch the door handle, Porsche Entry & Drive checks the encrypted access code on the key in your pocket. Once the key is validated, the door unlocks. The vehicle can then be started or switched off using the electronic ignition switch. To lock the vehicle, you simply press a button on the outside of the door handle. Porsche Entry & Drive then locks the vehicle and activates the engine immobilizer and steering-column lock.

Anti-Theft Protection

All Panamera models are protected by an immobilizer and an alarm system including ultrasonic interior surveillance. The system secures all four doors, the hood, the rear hatch, the passenger compartment, the ignition, the steering column, and any trailer that may be attached.







Panamera with 19-inch Panamera Classic wheels

Panamera was conceived so you could invite others to enjoy the Porsche experience. Go ahead—there's plenty of room.

Luggage compartment.

The Panamera offers up to 15.72 cubic feet of luggage space. The Panamera S E-Hybrid provides you with 11.83 cubic feet of luggage compartment capacity, and the Panamera Turbo 15.26 cubic feet. All models offer enough room for four suitcases from the Driver's Selection by Porsche Design range—color-coordinated with the exterior color of your Panamera if you wish.

The automatic rear hatch with customizable opening angle is fitted as standard to all models. It closes conveniently at the push of a button.

The rear seats fully fold or split-fold—an uncommon feature in this vehicle class. The cargo position offers 44.6 cubic feet of space. The Panamera S E-Hybrid offers 40.0 cubic feet and the Panamera Turbo has 44.1 cubic feet.

A ski bag is available as an option and, to accommodate it, the center section between the rear seats folds separately. To protect from prying eyes, the luggage compartment can be covered with the removable roller cover that also comes standard.

The fixed luggage compartment cover is available as an option. For extra protection for the luggage compartment, this cannot be removed until the rear hatch is opened. A roll-up sunblind offered as an option is compatible with either luggage cover. Controlled electrically, it can be raised behind the rear seats for extra privacy.



A Porsche is a very personal statement. You can make it even more so, by choosing from a range of colors, materials, and features that express your individuality.

Expression and strengths. Individuality.







Colors.

The extensive color range of the Panamera models offers no fewer than 15 exterior colors. Then there are six interior colors, six two-tone combinations, optional Alcantara® colors for the Panamera GTS, plus eight interior packages in Aluminum, Carbon Fiber, and a selection of Woods.

Using the Porsche Car Configurator at [porscheusa.com](https://www.porscheusa.com), you can see how the available colors would look on your computer-generated car, not only on the exterior, but in the interior too. Can't find the exact color you'd like for your Panamera? Through our Porsche Exclusive program of customization options, we can likely mix it for you. For more information, see the Porsche Exclusive Panamera catalog.

Solid exterior colors.

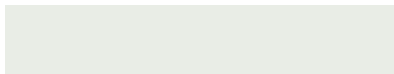

White



Black



Metallic exterior colors.



Basalt Black Metallic



Carbon Grey Metallic



Rhodium Silver Metallic



Dark Blue Metallic



Agate Grey Metallic



Special exterior colors



Chestnut Brown Metallic



GT Silver Metallic



Ruby Red Metallic



Cognac Metallic



Mahogany Metallic



Amethyst Metallic



Yachting Blue Metallic



Carmine Red



Standard interior colors.

Seat/interior.



Black

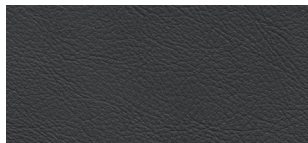

Agate Grey

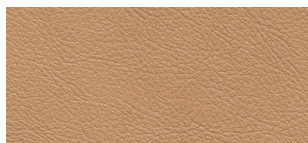

Luxor Beige

Carpet.



Black



Agate Grey



Luxor Beige

Floor mats.



Black



Agate Grey



Luxor Beige

Roof liner.



Platinum Grey



Platinum Grey

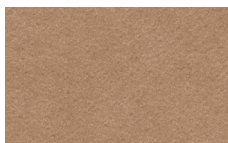

Luxor Beige

Standard interior colors: Leather interior.

Seat/interior.

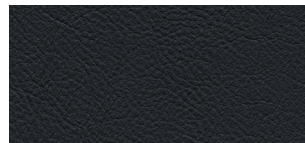

Black

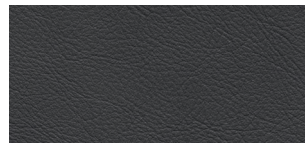

Agate Grey

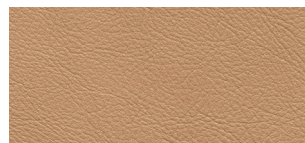

Luxor Beige

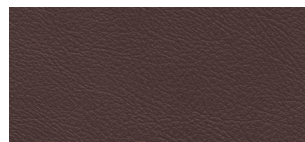

Marsala

Carpet.



Black



Agate Grey



Luxor Beige



Marsala

Floor mats.

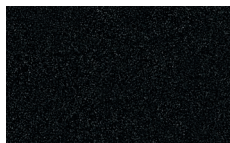

Black



Agate Grey



Luxor Beige



Marsala

Roof liner.

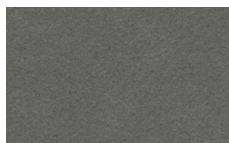

Platinum Grey

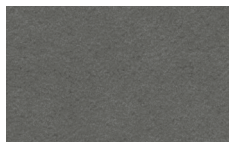

Platinum Grey

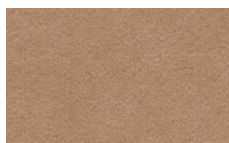

Luxor Beige

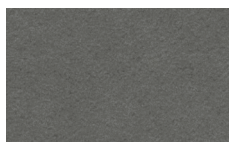

Platinum Grey



Interior in two-tone combination (Cognac and Cedar), Yachting Mahogany interior package

Two-tone combinations: Leather interior.

Seat/interior.



Luxor Beige and Cream

Carpet.

Cream¹

Floor mats.

Cream¹

Roof liner.

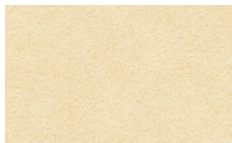

Cream

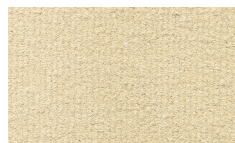
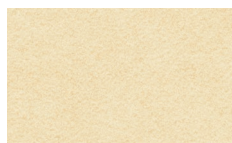

Marsala and Cream

Cream¹Cream¹

Cream

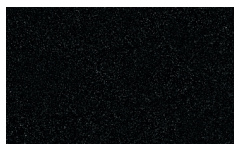
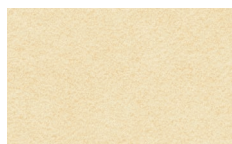

Black and Cream

Black¹Black¹

Cream

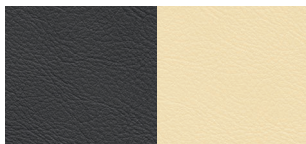

Agate Grey and Cream

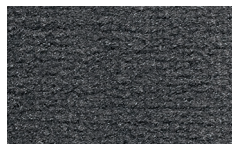
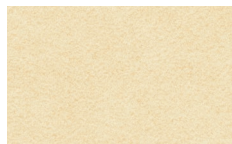
Agate Grey¹Agate Grey¹

Cream

Two-tone combinations: Leather interior.

Seat/interior.

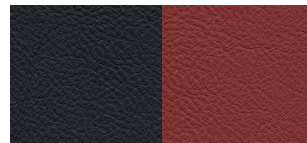

Black and Carrera Red

Carpet.

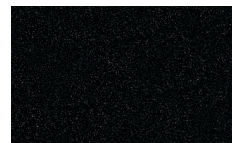
Black¹

Natural Leather interior.

Floor mats.

Roof liner.

Seat/interior.

Carpet.

Floor mats.

Roof liner.



Black¹



Black

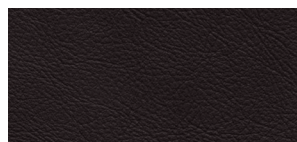

Espresso



Espresso



Espresso



Platinum Grey²

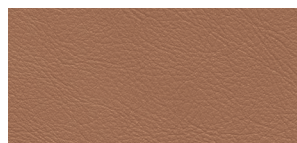

Cognac



Cognac



Cognac



Cedar



Cognac and Cedar

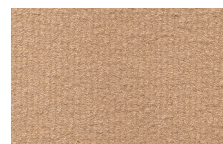

Cedar



Cedar



Cedar

¹With two-tone packages, the luggage compartment is styled in the respective darker color.

²In conjunction with roof liner in black Alcantara® (standard in the Panamera GTS and Panamera Turbo models).

Interior trims.

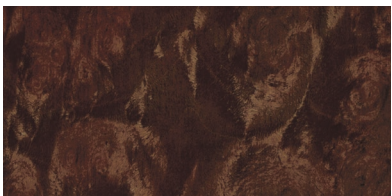

Dark Walnut

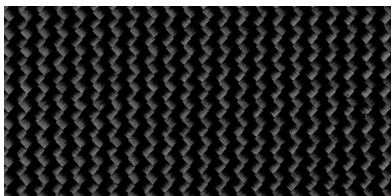

Carbon Fiber



Brushed Aluminum

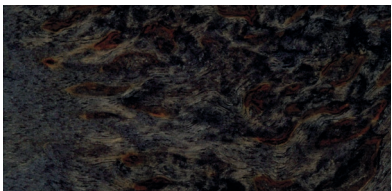

Anthracite Birch



Tineo

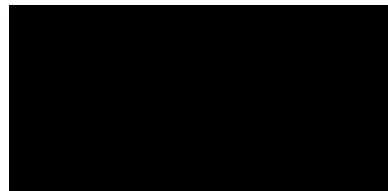

Black (high-gloss)



Natural Olive



Yachting Mahogany

Options.

The comprehensive specification of the Panamera model range may be second to none, but at Porsche we appreciate that you may wish to tailor your Panamera entirely to your personal preferences. After all, every Porsche should have its own unique character.

There is a variety of individual items and equipment packages for the exterior and interior to choose from. You will find more detailed information at [porscheusa.com](https://www.porscheusa.com).

These are just some of the many ways to style your Panamera to your personal preferences. How about having your car personalized at the factory through Porsche Exclusive, or why not consider our range of aftermarket accessories from Porsche Tequipment? You will find plenty of inspiring ideas in all the relevant catalogs and your Authorized Porsche dealer will be happy to advise you.



Product	Panamera	Panamera 4	Panamera S	Panamera 4S	Panamera S E-Hybrid	Panamera GTS	Panamera Turbo	Code	Page
Exterior.									
Metallic paint	○	○	○	○	○	○	●	Code	111
Special colors	○	○	○	○	○	○	○	Code	112
Color to sample	○	○	○	○	○	○	○		
Side skirts, painted	–	–	–	–	–	□	–	569	
Bi-Xenon™ headlights including Porsche Dynamic Light System (PDLS)	○	○	●	●	●	●	●	603	70
LED headlights including Porsche Dynamic Light System Plus (PDLS Plus)	○	○	○	○	○	○	○	602	71, 120
Porsche Entry & Drive	○	○	○	○	○	○	●	625	103, 120
ParkAssist (front and rear) with reversing camera	○	○	○	○	○	○	○	638	99
ParkAssist (front and rear) with Surround View	○	○	○	○	○	○	○	633	99, 120
SportDesign side skirts	○	○	○	○	○	○	○	XAR	
LED headlights in black including Porsche Dynamic Light System Plus (PDLS Plus)	○	○	○	○	○	○	○	XEY	120

– not available ○ option available at extra cost ● standard equipment □ available at no extra cost





Front camera, Surround View



LED headlights including Porsche Dynamic Light System Plus (PDLS Plus)



Porsche Entry & Drive



Roof Transport System



Electric slide/tilt glass sunroof

Product	Panamera	Panamera 4	Panamera S	Panamera 4S	Panamera S E-Hybrid	Panamera GTS	Panamera Turbo	Code	Page
Exterior.									
Thermal and noise-insulated glass	<input type="radio"/>	<input type="radio"/>	<input type="radio"/>	<input type="radio"/>	<input type="radio"/>	<input type="radio"/>	<input type="radio"/>	865	84
Electric slide/tilt glass sunroof	<input type="radio"/>	<input type="radio"/>	<input type="radio"/>	<input type="radio"/>	<input type="radio"/>	<input type="radio"/>	<input type="radio"/>	650	121
“Panamera GTS” logo on the doors	–	–	–	–	–	<input type="checkbox"/>	–	516	
Roof Transport System	<input type="radio"/>	<input type="radio"/>	<input type="radio"/>	<input type="radio"/>	<input type="radio"/>	<input type="radio"/>	<input type="radio"/>	549	121
Rear wiper	<input type="radio"/>	<input type="radio"/>	<input type="radio"/>	<input type="radio"/>	<input checked="" type="radio"/>	<input type="radio"/>	<input type="radio"/>	425	
Deletion of model designation	<input type="checkbox"/>	<input type="checkbox"/>	<input type="checkbox"/>	<input type="checkbox"/>	<input type="checkbox"/>	<input type="checkbox"/>	<input type="checkbox"/>	498	
Exterior package in black (high-gloss)	<input type="radio"/>	<input type="radio"/>	<input type="radio"/>	<input type="radio"/>	<input type="radio"/>	<input checked="" type="radio"/>	<input type="radio"/>	806	117
Fuel cap with Aluminum-Look finish	<input type="radio"/>	<input type="radio"/>	<input type="radio"/>	<input type="radio"/>	<input type="radio"/>	<input type="radio"/>	<input type="radio"/>	XEY	
Tinted LED taillights	<input type="radio"/>	<input type="radio"/>	<input type="radio"/>	<input type="radio"/>	<input type="radio"/>	<input checked="" type="radio"/>	<input type="radio"/>	XXP	

– not available option available at extra cost standard equipment available at no extra cost

Product	Panamera	Panamera 4	Panamera S	Panamera 4S	Panamera S E-Hybrid	Panamera GTS	Panamera Turbo	Code	Page
Engine, transmission, and chassis.									
Porsche Active Suspension Management (PASM)	○	○	●	●	●	●	●	475	62, 65
Adaptive Air Suspension including PASM	○	○	○	○	●	●	●	350/351	62
Porsche Dynamic Chassis Control (PDCC) including Porsche Torque Vectoring Plus (PTV Plus)	○	○	○	○	—	○	○	715	64
Power Steering Plus	○	○	○	○	●	○	○	658	59
Sport Chrono Package	○	○	○	○	○	●	○	640	65, 123
Porsche Ceramic Composite Brakes (PCCB)	○	○	○	○	○	○	○	450	73, 124
Sport exhaust system	—	—	○	○	—	●	○	176/XLF	40, 54, 124
Extended-range fuel tank	○	○	○	●	●	●	●	081	
Sport tailpipes in High-Gloss Chrome	○	○	○	○	○	○	○	XLR	
Sport tailpipes in black Chrome	○	○	○	○	○	○	○	XLP	

— not available ○ option available at extra cost ● standard equipment □ available at no extra cost



Sport Chrono Package



Porsche Ceramic Composite Brake (PCCB)



Tailpipes of the Sport exhaust system in black



Rapid cornering without PDCC (illustrative example)



Rapid cornering with PDCC (illustrative example)



18-inch Panamera wheel



18-inch Panamera S wheel



19-inch Panamera Turbo wheel



19-inch Panamera Turbo II wheel



19-inch Panamera Classic wheel



20-inch RS Spyder Design wheel



20-inch Panamera Sport wheel



20-inch Panamera Sport wheels, painted in black (high-gloss)

– not available ○ option available at extra cost ● standard equipment □ available at no extra cost



19-inch Panamera Design II wheel



20-inch 911 Turbo II wheel

Product	Panamera	Panamera 4	Panamera S	Panamera 4S	Panamera S E-Hybrid	Panamera GTS	Panamera Turbo	Code	Page
Wheels.									
18-inch Panamera wheels	●	●	□	□	□	–	–	410	16, 125
18-inch Panamera S wheels	○	○	●	●	●	–	–	413	25, 125
19-inch Panamera Turbo wheels	○	○	○	○	○	□	□	415	125
19-inch Panamera Turbo II wheels	○	○	○	○	○	●	●	471	45, 125
19-inch Panamera Design II wheels	○	○	○	○	○	○	○	472	126
19-inch Panamera Classic wheels	○	○	○	○	○	○	○	436	105, 125
20-inch RS Spyder Design wheels	○	○	○	○	○	○	○	417	36, 125
20-inch Panamera Sport wheels	○	○	○	○	○	○	○	XRW	6, 125
20-inch Panamera Sport wheels, painted	○	○	○	○	○	○	○	XRX	
20-inch Panamera Sport wheels, painted in black (high-gloss)	○	○	○	○	○	○	○	XRY	125
20-inch 911 Turbo II wheels	○	○	○	○	○	○	○	418	42, 126
20-inch Sport Classic wheels	□	□	□	□	□	□	□	XRU	
20-inch Sport Classic wheels, painted in black	○	○	○	○	○	○	○	XR2	
Standard with 19-inch alloy wheels	○	○	○	○	○	○	●	231	
All-season tires for 20-inch alloy wheels	○	○	○	○	○	○	○	234	
Wheel center caps with colored Porsche Crest	○	○	○	○	○	●	○	446	
Wheel spacers, 5mm	○	○	○	○	○	●	○	856	

Product	Panamera	Panamera 4	Panamera S	Panamera 4S	Panamera S E-Hybrid	Panamera GTS	Panamera Turbo	Code	Page
Interior.									
Adaptive Cruise Control including Porsche Active Safe (PAS)	○	○	○	○	○	○	○	456	99
Lane Change Assist (LCA)	○	○	○	○	○	○	○	457	101, 102
Lane Departure Warning (LDW)	○	○	○	○	○	○	○	458	102
Soft-close doors	○	○	○	○	○	○	○	885	84
14-way power seats with memory package	○	○	○	○	○	–	●	P80	85, 127
18-way Adaptive Sport Seats with memory package	○	○	○	○	○	●	○	P81	85
8-way power seats (rear)	○	○	○	○	○	○	○	834	87, 88
8-way power seats (rear) with comfort headrests	○	○	○	○	○	○	○	834	87, 88
8-way power seats (rear) (in conjunction with large center console)	○	○	○	○	○	○	○	836	87
8-way power seats (rear) (in conjunction with large center console) with comfort headrests	○	○	○	○	○	○	○	836	87
8-way power seats (rear) (in conjunction with Adaptive Sport Seats)	○	○	○	○	○	○	○	835	88
Seat heating (front and rear)	○	○	○	○	○	○	●	343	88
Seat ventilation (front)	○	○	○	○	○	○	○	541	88
Seat ventilation (front and rear)	○	○	○	○	○	○	○	542	88



14-way power seats with memory package

- not available
- option available at extra cost
- standard equipment
- available at no extra cost

Product	Panamera	Panamera 4	Panamera S	Panamera 4S	Panamera S E-Hybrid	Panamera GTS	Panamera Turbo	Code	Page
Interior.									
Interior lighting package for rear compartment	○	○	○	○	○	○	○	630	83, 84
Multifunction steering wheel	●	●	●	●	●	□	●	844	59
SportDesign steering wheel	□	□	□	□	□	●	□	840	59
Auxiliary climate control*	–	–	–	–	○	–	–	854	
4-zone automatic climate control	○	○	○	○	○	○	○	576	84
Steering wheel heating	○	○	○	○	○	○	○	345	
Instrument dials in White	○	○	○	○	○	○	○	XFJ	
Instrument dials in Luxor Beige	○	○	○	○	–	○	○	XFL	
Instrument dials in Guards Red	○	○	○	○	–	○	○	XFO	
Seat belts in Silver Grey	○	○	○	○	○	○	○	XSH	
Seat belts in Guards Red	○	○	○	○	○	○	○	XSX	
Large rear center console	○	○	○	○	○	○	○	838	81, 87
Electric roll-up sunblind for behind rear compartment	○	○	○	○	○	○	○	862	84, 128
Electric roll-up sunblind for rear side windows	○	○	○	○	○	○	○	861	84, 128
Ski bag	○	○	○	○	○	○	○	213	87, 106
Retractable luggage compartment cover	○	○	○	○	○	○	○	868	106
Fire extinguisher	○	○	○	○	○	○	○	509	



Large center console in rear



Roll-up sunblind

*On the Panamera S E-Hybrid with e-mobility services, you can remotely activate the climate control system of your vehicle as desired.



Leather interior in two-tone combination (Marsala and Cream), interior package in black (high-gloss), and other optional equipment



Natural Leather interior in two-tone combination (Cognac and Cedar), Yachting Mahogany interior package, and other optional equipment



Leather interior in Luxor Beige, Dark Walnut interior package, and other optional equipment



Product	Panamera	Panamera 4	Panamera S	Panamera 4S	Panamera S E-Hybrid	Panamera GTS	Panamera Turbo	Code	Page
Interior: black (high-gloss).									
Interior package in black (high-gloss)	•	•	•	•	•	□	□	817	117, 129
Interior: Leather.									
Standard interior for Panamera	•	•	•	•	•	–	–	Code	113
Leather interior for Panamera, Smooth-Finish Leather	○	○	○	○	○	□	•	Code	
Leather interior for Panamera, Smooth-Finish Leather, Alcantara®	–	–	–	–	–	•	–	Code	
Leather interior in two-tone combination	○	○	○	○	○	○	○	970	9, 129
Leather interior in Natural Leather	○	○	○	○	○	○	○	998	
Leather interior in Natural Leather, two-tone combination	○	○	○	○	○	○	○	Code	
Soft ruffled Leather on seats (in conjunction with standard interior)	○	○	○	○	○	–	–	947	
Soft ruffled Leather on seats (in conjunction with Leather interior)	○	○	○	○	○	○	○	982	
Extended interior package in Leather	○	○	○	○	○	○	○	XHA	
GTS interior package in GT Silver	–	–	–	–	–	○	–	GS	
GTS interior package in Carmine Red	–	–	–	–	–	○	–	GK	39
Interior: Alcantara®.									
Roof liner in Alcantara®	○	○	○	○	○	•	•	594	
SportDesign steering wheel in Alcantara®	○	○	○	○	○	○	○	843	

– not available • option available at extra cost • standard equipment □ available at no extra cost

Product	Panamera	Panamera 4	Panamera S	Panamera 4S	Panamera S E-Hybrid	Panamera GTS	Panamera Turbo	Code	Page
Interior: Wood.									
Dark Walnut interior package	○	○	○	○	○	○	●	826	129
Heated multifunction steering wheel in Dark Walnut	○	○	○	○	○	○	○	842	
Tineo interior package	○	○	○	○	○	○	■	822	132
Heated multifunction steering wheel in Tineo	○	○	○	○	○	○	○	849	
Anthracite Birch interior package	○	○	○	○	○	○	■	823	132
Heated multifunction steering wheel in Anthracite Birch	○	○	○	○	○	○	○	848	
Natural Olive interior package	○	○	○	○	○	○	■	824	132
Yachting Mahogany interior package	○	○	○	○	○	○	○	XZY	129
Exclusive									
Heated multifunction steering wheel in Yachting Mahogany	○	○	○	○	○	○	○	XZZ	
Exclusive									
Interior: Carbon Fiber.									
Carbon Fiber interior package	○	○	○	○	○	○	●	819	9
Heated multifunction steering wheel in Carbon Fiber	○	○	○	○	○	○	○	845	
Door-entry guards in Carbon Fiber	○	○	○	○	○	○	○	X69, XXD	
Interior: Aluminum.									
Brushed Aluminum interior package	○	○	○	○	○	○	■	818	33
Door-entry guards in Brushed Aluminum	○	○	○	○	○	○	○	597	
Pedals in Aluminum	○	○	○	○	○	○	○	XXV	

– not available ● option available at extra cost ○ standard equipment ■ available at no extra cost





Leather interior in two-tone combination (Black and Cream), Anthracite Birch interior package, and other optional equipment



Leather interior in two-tone combination (Luxor Beige and Cream), Natural Olive interior package, and other optional equipment



Natural Leather interior in Espresso, Tineo interior package, and other optional equipment



6-disc CD/DVD changer



Burmester® High-End Surround Sound System



Bose® Surround Sound System

Product	Panamera	Panamera 4	Panamera S	Panamera 4S	Panamera S E-Hybrid	Panamera GTS	Panamera Turbo	Code	Page
Audio and communication options for vehicles with PCM.									
6-disc CD/DVD changer ¹	○	○	○	○	○	○	○	693	89
Bose® Surround Sound System ²	○	○	○	○	○	○	●	680	95
Burmester® High-End Surround Sound System ²	○	○	○	○	—	○	○	682	95
Telephone module with cordless handset	○	○	○	○	○	○	○	669	
SiriusXM® Satellite Radio receiver	○	○	○	○	○	○	—	686	91
SiriusXM® Satellite Radio receiver and HD Radio receiver	○	○	○	○	○	○	●	690	
HD Radio receiver	○	○	○	○	○	○	—	688	
Online Services	○	○	○	○	○	○	○	UN1	
Porsche Car Connect	○	○	○	○	●	○	○	7G9	97, 98
Porsche Rear Seat Entertainment	○	○	○	○	○	○	○	CEU	93, 94
Exclusive									
Additional charging cradle for cordless handset in rear compartment	○	○	○	○	○	○	○	626	
Voice-control system	○	○	○	○	○	○	○	671	92
Electronic logbook	○	○	○	○	○	○	○	641	92

¹May be incompatible with some copy-protected CDs.

²Only available as part of Audio Package.



Porsche Exclusive.

A distinctive identity is another form of exclusivity.

At Porsche, we know how passionate people are about what they drive, and how personally connected they feel to their Porsche. Porsche Exclusive lets you express your passion to its fullest. It starts with the right advice to complement your exclusive wishes and requirements. We offer personal support

and individual expert advice to each and every customer. So why wait? Make an appointment with your Authorized Porsche dealer to discuss your requirements.

For the truly personal touch, contact our Porsche Customer Consultation Specialists at: **customerconsultations@porsche.us**.

You can see what we really mean by “customization” by making an appointment to visit our Customer Consultation Center in Beverly Hills, California. Here, you can select the materials, such as Leather, Wood, Carbon Fiber, or Aluminum, and the paint finish you desire. With the advanced Porsche Car Configurator, you

will be able to see a nearly life-size wall display of your creation. The Porsche New-Vehicle Limited Warranty applies for all Porsche Exclusive options and special designs. Please understand that some Porsche Exclusive options may require a longer delivery lead time.

Porsche Car Configurator.

With the Porsche Car Configurator, you can see the result instantly on your computer. Just four steps is all it takes to create your own Porsche.

It's as simple as selecting or deselecting the options you want. The price is recalculated automatically with each click. It looks stunning because the features are rendered in 3-D. So you can view your configuration from any angle, save it, and print it off then and there.

Visit porscheusa.com to access the Porsche Car Configurator and experience the fascinating world of Porsche.

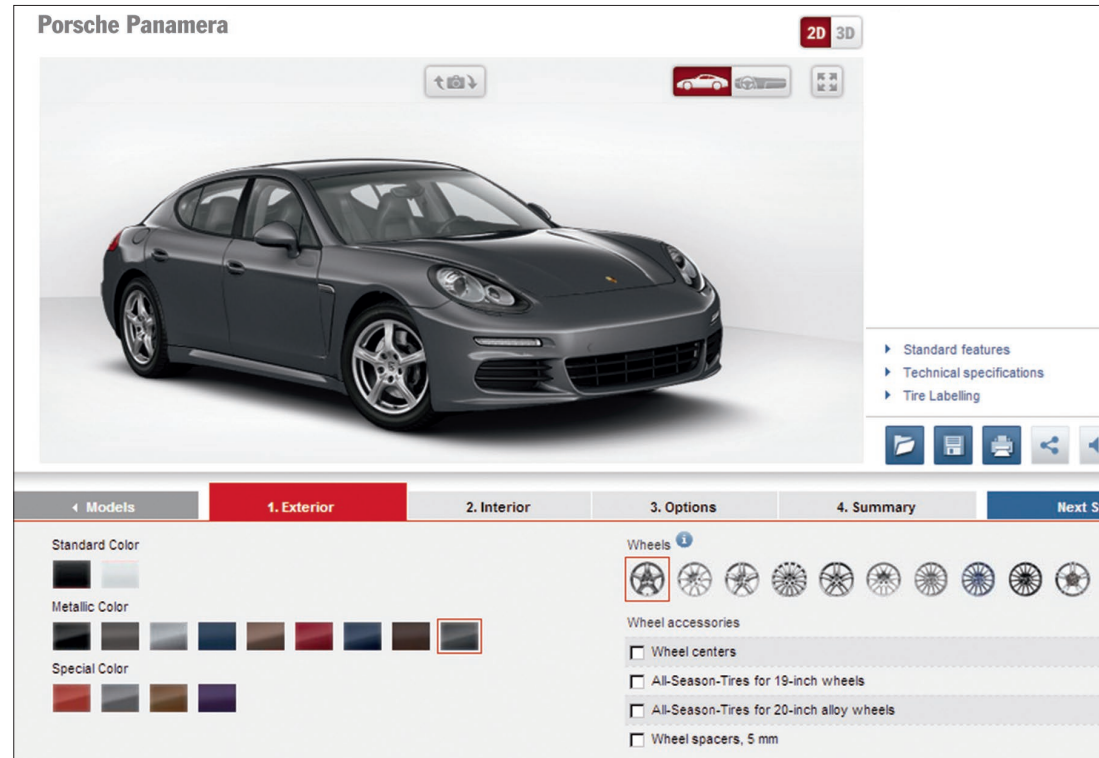

Porsche Driving Experience.

The Porsche Sport Driving School

At Porsche, we're interested not only in the evolution of our sports cars—we're also focused on evolving the skills of Porsche drivers. We created the Porsche Sport Driving School as a way to enhance the skills of drivers at all levels. Located at the Barber Motorsports Park near Birmingham, Alabama, the school is higher education for those who love high performance. In your own vehicle or one owned by the Porsche Sport Driving School, and

under the guidance of our experienced Porsche instructors, we introduce new Porsche owners to the fundamentals of driving dynamics and driving techniques. And we train more experienced drivers to master a sports car within its dynamic limits. We accompany you right from the start and guide you—if you wish—through the various training levels, right through to being awarded your motorsport license. Regardless of your experience, the Porsche Sport Driving School helps you to develop

your driving safety, and gradually optimize and perfect your driving skills.

To find out more, go to porschedriving.com.

Porsche Travel Club

Whether your vacation is for a few hours, a few days, or a few weeks, with the Porsche Travel Club as your host, you'll have an exceptional travel companion—a Porsche. Leave your cares behind and join us as we travel some of the best roads in the world in the most beautiful regions of

the world. It's truly a unique experience, with an exclusive supporting program: You stay overnight in first-class hotels and dine in the best restaurants located along the route. With the Porsche Travel Club, you'll experience something that you simply cannot describe in words: the true feeling of driving a Porsche.

To find out more, go to porscheusa.com.



Porsche European Delivery.

The first time you drive a new Porsche is always a special moment. With Porsche European Delivery, you can make it even more special. Take delivery of your new Panamera in Stuttgart-Zuffenhausen or Leipzig and be the one to take it to its rightful place: on the roads of Europe.

Before your Porsche is delivered to you, you'll be invited behind the scenes of the Porsche factory. As part of a guided tour of the production process, you will see how much passion and

precision goes into everything we do. You can then take time to reflect on your experience over a leisurely lunch and look forward to the high point of the day: taking delivery of your Porsche. Our specialists will take their time to explain everything about your new Panamera in as much detail as you wish.

That leaves you with just one more thing to decide: At which of our factories do you wish to take delivery? Stuttgart-Zuffenhausen is steeped in tradition and

history. Here, you can visit the Porsche Museum to experience and learn about every aspect of the Porsche brand, with legendary models from a sports car history spanning over 60 years.

Or, if you would prefer your factory collection to be a little more on the sporty side, visit our production location in Leipzig. Your first driving experience will be a test drive in a Porsche model identical to the one you have purchased and under the expert supervision of

one of our instructors. Hone your skills on-road on the FIA-certified test circuit or off-road in a Porsche off-roader on our very own off-road track.

For more information, please contact your Authorized Porsche dealer.



Panorama.



Porsche European Delivery

Imagine touring the original factory and then being handed the keys for an even more gratifying opportunity: touring Europe in your brand-new Porsche vehicle. What happens next is up to you. Contact your local Authorized Porsche dealer for more information.

Porsche Approved Certified Pre-Owned

A meticulous 111-point inspection, a 2-year or 50,000-mile limited warranty, and 24-Hour Roadside Assistance make this program one of a kind. Contact your Authorized Porsche dealer for details.



Porsche Exclusive

Realize your vision of the perfect Porsche with our factory customization program. From styling enhancements to performance upgrades, all modifications are uniquely handcrafted for your Porsche.

Porsche Classic

Your specialist source for genuine Porsche parts and technical documentation, as well as servicing, repair, and restoration for all types of Porsche classics. For more information, visit porscheusa.com/classic.



Porsche Tequipment

Personalize your Porsche at any time after purchase with the Tequipment range of approved accessories. Designed exclusively for your Porsche, every product is fully guaranteed.

Christophorus

Our bimonthly magazine for Porsche owners is packed with news, articles, and exclusive interviews covering every aspect of Porsche automobiles and the Porsche lifestyle.





Porsche Roadside Assistance

Your ownership experience is enhanced with complimentary enrollment in the Porsche 24-Hour Roadside Assistance program. It includes coverage 24 hours a day, 365 days a year, for the duration of your warranty. Contact your Authorized Porsche dealer for specifics.



Porsche Financial Services

Competitive, convenient, and carefully crafted financing options can be customized to meet your needs. Ask your certified Porsche Sales Consultant for details.



Driver's Selection by Porsche Design

With products ranging from fashion and accessories to tailored luggage, this unique collection combines quality and style with everyday practicality.

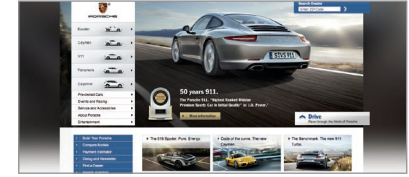

Porsche Online

Explore the world of Porsche at **porscheusa.com**. News, information, and videos are at your fingertips. Even create a car as individual as you are with the online Porsche Car Configurator.

Follow us on:



Porsche Travel Club

Exclusive driving holidays and incentive ideas combining luxury and adventure, worldwide. To find out more, contact us by e-mail at **travel.club@porsche.us**.

Porsche Sport Driving School

Develop your skill and explore your Porsche with the Porsche Sport Driving School. Learn firsthand from famed Porsche Racing drivers while they teach you at a world-class racing facility. Visit **porschedriving.com** for more information.

Porsche Clubs

With more than 120,000 members worldwide in 60 countries, know you are not alone in your passion for Porsche. Learn more about the brand and meet other Porsche enthusiasts just like yourself. Visit **porscheusa.com** for more information.

Porsche Museum

More than 80 vehicles are waiting to take you back through every stage of Porsche history. They include such icons as the 356, 911, and 917, and many other special exhibits presented in an atmosphere you can't experience anywhere else.



You can obtain the latest brochures for Porsche Exclusive, Driver's Selection by Porsche Design, and Porsche Sport Driving Schools from your Authorized Porsche dealer.



PORSCHE

Panamera GTS

D S VM 4106



Decision and horizon. Summary.

Sometimes one life is not enough. There is so much to see and do. Then again, why couldn't we live two lives at once? Why couldn't we sit in a sedan and drive a sports car at the same time?

The new Panamera models offer an enticing solution and provide an exciting experience for the next horizon.

Technical data.

	Panamera	Panamera 4
Engine		
Cylinders	6	6
Displacement	3.6 liters	3.6 liters
Max. power (DIN) at rpm	310 hp at 6200 rpm	310 hp at 6200 rpm
Max. torque at rpm	295 lb.-ft. at 3750 rpm	295 lb.-ft. at 3750 rpm
Compression ratio	12.5:1	12.5:1
Transmission		
Layout	Rear-wheel drive	All-wheel drive
PDK (7-speed)	Standard	Standard
Tiptronic S (8-speed)	–	–
Chassis		
Front axle	Aluminum double-wishbone	Aluminum double-wishbone
Rear axle	Aluminum multi-link with chassis subframe	Aluminum multi-link with chassis subframe
Steering	Variable-steering ratio	Variable-steering ratio
Brakes	6-piston, aluminum monobloc fixed calipers (front) 360 mm, 4-piston, aluminum monobloc fixed calipers (rear) 330 mm, integral brake rotors internally vented and slotted	6-piston, aluminum monobloc fixed calipers (front) 360 mm, 4-piston, aluminum monobloc fixed calipers (rear) 330 mm, integral brake rotors internally vented and slotted
Standard wheels	Front: 8J x 18 ET 59; Rear: 9J x 18 ET 53	Front: 8J x 18 ET 59; Rear: 9J x 18 ET 53
Standard tires	Front: 245/50 ZR 18; Rear: 275/45 ZR 18	Front: 245/50 ZR 18; Rear: 275/45 ZR 18

	Panamera S	Panamera 4S
Engine		
Cylinders	6	6
Displacement	3.0 liters	3.0 liters
Max. power (DIN) at rpm	420 hp at 6000 rpm	420 hp at 6000 rpm
Max. torque at rpm	384 lb.-ft. between 1750 and 5000 rpm	384 lb.-ft. between 1750 and 5000 rpm
Compression ratio	9.8:1	9.8:1
Transmission		
Layout	Rear-wheel drive	All-wheel drive
PDK (7-speed)	Standard	Standard
Tiptronic S (8-speed)	–	–
Chassis		
Front axle	Aluminum double-wishbone	Aluminum double-wishbone
Rear axle	Aluminum multi-link with chassis subframe	Aluminum multi-link with chassis subframe
Steering	Variable-steering ratio	Variable-steering ratio
Brakes	6-piston, aluminum monobloc fixed calipers (front) 360 mm, 4-piston, aluminum monobloc fixed calipers (rear) 330 mm, integral brake rotors internally vented and slotted	6-piston, aluminum monobloc fixed calipers (front) 360 mm, 4-piston, aluminum monobloc fixed calipers (rear) 330 mm, integral brake rotors internally vented and slotted
Standard wheels	Front: 8J x 18 ET 59; Rear: 9J x 18 ET 53	Front: 8J x 18 ET 59; Rear: 9J x 18 ET 53
Standard tires	Front: 245/50 ZR 18; Rear: 275/45 ZR 18	Front: 245/50 ZR 18; Rear: 275/45 ZR 18

Technical data.

	Panamera S E-Hybrid	Panamera GTS
Engine		
Cylinders	6	8
Displacement	3.0 liters	4.8 liters
Max. power (DIN) at rpm	333 hp between 5500 and 6500 rpm	440 hp at 6700 rpm
Max. torque at rpm	325 lb.-ft. between 3000 and 5250 rpm	384 lb.-ft. at 3500 rpm
Compression ratio	10.5:1	12.5:1
Max. power electric motor at rpm	95 hp between 2200 and 2600 rpm	–
Max. torque electric motor at rpm	229 lb.-ft. < 1700 rpm	–
Max. power Parallel Full Hybrid at rpm	416 hp at 5500 rpm	–
Max. torque Parallel Full Hybrid at rpm	435 lb.-ft. between 1250 and 4000 rpm	–
Transmission		
Layout	Rear-wheel drive	All-wheel drive
PDK (7-speed)	–	Standard
Tiptronic S (8-speed)	Standard	–
Chassis		
Front axle	Aluminum double-wishbone	Aluminum double-wishbone
Rear axle	Aluminum multi-link with chassis subframe	Aluminum multi-link with chassis subframe
Steering	Power Steering Plus	Variable-steering ratio
Brakes	6-piston, aluminum monobloc fixed calipers (front) 360 mm, 4-piston, aluminum monobloc fixed calipers (rear) 330 mm, integral brake rotors internally vented and slotted	6-piston, aluminum monobloc fixed calipers (front) 390 mm, 4-piston, aluminum monobloc fixed calipers (rear) 350 mm, composite brake discs (front), integral brake rotors (rear), internally vented and slotted
Standard wheels	Front: 8J x 18 ET 59; Rear: 9J x 18 ET 53	Front: 9J x 19 ET 60; Rear: 10J x 19 ET 61
Standard tires	Front: 245/50 ZR 18; Rear: 275/45 ZR 18	Front: 255/45 19; Rear: 285/40 19

	Panamera Turbo
Engine	
Cylinders	8
Displacement	4.8 liters
Max. power (DIN) at rpm	520 hp at 6000
Max. torque at rpm	516 lb.-ft. between 2250 and 4500
Compression ratio	10.5:1
Max. power electric motor at rpm	–
Max. torque electric motor at rpm	–
Max. power Parallel Full Hybrid at rpm	–
Max. torque Parallel Full Hybrid at rpm	–
Transmission	
Layout	All-wheel drive
PDK (7-speed)	Standard
Tiptronic S (8-speed)	–
Chassis	
Front axle	Aluminum double-wishbone
Rear axle	Aluminum multi-link with chassis subframe
Steering	Variable-steering ratio
Brakes	6-piston, aluminum monobloc fixed calipers (front) 390 mm, 4-piston, aluminum monobloc fixed calipers (rear) 350 mm, composite brake discs (front), integral brake rotors (rear), internally vented and slotted
Standard wheels	Front: 9J x 19 ET 60; Rear: 10J x 19 ET 61
Standard tires	Front: 255/45 19; Rear: 285/40 19

Technical data.

	Panamera	Panamera 4	Panamera S	Panamera 4S
Weights				
Curb weight (lb.)	3,902 lb.	4,012 lb.	3,990 lb.	4,123 lb.
Gross vehicle weight	5,247 lb.	5,335 lb.	5,324 lb.	5,401 lb.
Payload	1,334 lb.	1,279 lb.	1,334 lb.	1,279 lb.
Performance				
Top track speed	160 mph	159 mph	178 mph	177 mph
0–60 mph	6.0 secs (5.7 secs) ¹	5.8 secs (5.5 secs) ¹	4.9 secs (4.6 secs) ¹	4.6 secs (4.3 secs) ¹
1/4 mile from standing start	14.5 secs	14.4 secs	13.2 secs (13.0 secs) ¹	12.9 secs (12.7 secs) ¹
Fuel consumption/emissions^{2,3}				
City	18	18	17	17
Highway	28	27	27	27
Combined	22	21	21	21
Dimensions				
Length	197.44 in.	197.44 in.	197.44 in.	197.44 in.
Width (with exterior mirrors)	76.02 in. (83.23 in.)	76.02 in. (83.23 in.)	76.02 in. (83.23 in.)	76.02 in. (83.23 in.)
Height	55.8 in.	55.8 in.	55.8 in.	55.8 in.
Wheelbase	114.96 in.	114.96 in.	114.96 in.	114.96 in.
Cargo area with folded-down rear seats	44.6 cu. ft.	44.6 cu. ft.	44.6 cu. ft.	44.6 cu. ft.
Fuel tank capacity	21.1 gal.	21.1 gal.	21.1 gal.	26.4 gal.

¹In conjunction with the optional Sport Chrono Package with activated Sport Plus button selected.

²As of the time of printing, the EPA numbers are to be determined. Please see your Authorized Porsche dealer or visit porscheusa.com for the latest information. Your mileage and range may vary.

³2013 U.S. EPA estimates. Your mileage may vary.

	Panamera S E-Hybrid	Panamera GTS	Panamera Turbo
Weights			
Curb weight (lb.)	4,619 lb.	4,244 lb.	4,343 lb.
Gross vehicle weight	5,688 lb.	5,512 lb.	5,512 lb.
Payload	1,279 lb.	1,235 lb.	1,169 lb.
Performance			
Top track speed	167 mph	179 mph	189 mph
0–60 mph	5.2 secs	4.2 secs	3.9 secs (3.7 secs) ¹
1/4 mile from standing start	13.8 secs	12.7 secs	12.1 secs
Fuel consumption/emissions^{2,3}			
City	TBD ²	16	15
Highway	TBD ²	24	24
Combined	TBD ²	19	18
Dimensions			
Length	197.44 in.	197.44 in.	197.44 in.
Width (with exterior mirrors)	76.02 in. (83.23 in.)	76.02 in. (83.23 in.)	76.02 in. (83.23 in.)
Height	83.23 in.	83.23 in.	83.23 in.
Wheelbase	114.96 in.	114.96 in.	114.96 in.
Cargo area with folded-down rear seats	40.0 cu. ft.	44.6 cu. ft.	44.1 cu. ft.
Fuel tank capacity	21.1 gal.	26.4 gal.	26.4 gal.

Index

A		D		I		M	
Adaptive Air Suspension	62	Design	7	Interior lighting	81, 83	Multifunction steering wheel	56, 59
Adaptive Cruise Control	99	Direct Fuel Injection (DFI)	50	Interior lighting package for rear compartment	83	N	
Air conditioning	97	E		Interior packages	113, 128–132	Navigation	89, 90
Airbags	75	“E-Power” meter	34	L		Noise- and thermally insulated glass	84
All-wheel drive	57	Electric motor	29	Lane Change Assist (LCA)	101	P	
Anti-theft protection	103	Electronic logbook	92	Lane Departure Warning (LDW)	102	Parallel Full Plug-In Hybrid	11, 29
Audio systems	89, 95, 133	Engines	49, 50	Launch Control	59	ParkAssist	99, 100
Auto Start Stop function	51	Environment	78	LED main headlights including Porsche Dynamic Light System Plus (PDLs Plus)	71, 120	Parking brake, electric	74
B		Exhaust system	54	Leveling system	62, 65	Payload	147
Bose® Surround Sound System	95, 133	Exterior	7, 119	Light-alloy construction	75	Porsche Active Safe (PAS)	99
Brakes	74	F		Lighting system	69–71	Porsche Active Suspension Management (PASM)	62
Burmester® High-End Surround Sound System	95, 133	Fuel system	50	Lights	81–85	Porsche Car Configurator	136
C		H		Lightweight exhaust system	54	Porsche Car Connect	31, 97
CD/DVD changer	89	Headlight-cleaning system	70	Loading options	106	Porsche Ceramic Composite Brakes (PCCB)	74, 124
Chassis	58	Headlights	71, 72	Luggage compartment	20, 105, 106	Porsche Communication Management (PCM)	89
Coasting	30, 51	Height adjustment	62			Porsche Doppelkupplung (PDK)	55
Colors	110	High-voltage nickel-metal hydride (NiMH) battery	11, 29			Porsche Dynamic Chassis Control (PDCC)	63, 64, 124
Cruise control	99	Hybrid module	11, 27, 29, 32				

Porsche Dynamic Light System (PDLS)	70	R	Radio	89, 92, 93	T	Technical data	143
Porsche Dynamic Light System Plus (PDLS Plus)	71, 72		Rear hatch	105		Thermally insulated glass	84
Porsche Entry & Drive	103		Recuperation	29		Tiptronic S	55
Porsche Rear Seat Entertainment	93		Recycling	78		Tire Pressure Monitoring System (TPMS)	61
Porsche Side Impact Protection (POSIP) system	75		Reversing camera	99		Touchscreen	89, 93
Porsche Stability Management (PSM)	64		Roll-up sunblinds	84, 106, 128		Transmission	55
Porsche Torque Vectoring Plus (PTV Plus)	64	S	Roof Transport System	121			
Porsche Traction Management (PTM)	58		S		U		
Power output	11, 24, 30, 35, 50		Seat-belt system	75		Universal audio interface	89, 91
Power seats with memory package	85, 127		Seat heating and ventilation	88		V	
Power Steering Plus	59		Seats	85, 127		Variable camshaft control	51
			Slide/tilt sunroof	121		VarioCam Plus	51
			Soft-close doors	84		Voice-control system	92
			Sport button	65		W	
			Sport Chrono Package	56, 59, 65, 123		Wheels	61, 125
			SportDesign steering wheel	59			
			Sport exhaust system	54, 124			
			Steering	59			
			Steering wheels	59			
			Surround View	99			



Porsche Cars North America, Inc.
980 Hammond Drive, Suite 1000
Atlanta, Georgia 30328



Dr. Ing. h.c. F. Porsche AG is the owner of numerous trademarks, both registered and unregistered, including without limitation the Porsche Crest®, Porsche®, Boxster®, Carrera®, Cayenne®, Cayman®, Panamera®, Speedster®, Spyder®, Tiptronic®, VarioCam®, PCM®, PDK®, 911®, RS® 4S®, 918 Spyder®, FOUR, UNCOMPROMISED.®, and the model numbers, and the distinctive shapes of the Porsche automobiles, such as the federally registered 911 and Boxster automobiles. The third-party trademarks contained herein are the properties of their respective owners. Porsche Cars North America, Inc., believes the specifications to be correct at the time of printing. Specifications, performance standards, standard equipment, options, and other elements shown are subject to change without notice. Some options may be unavailable when a car is built. Some vehicles may be shown with non-U.S. equipment. Please ask your dealer for advice concerning the current availability of options and verify the optional equipment that you ordered. Porsche recommends seat-belt usage and observance of traffic laws at all times.

All fuel consumption and emissions data contained herein are derived from U.S. tests and were accurate at time of press.

©2013 Porsche Cars North America, Inc.

Printed in the U.S.A.

MKT 001 023 13

porscheusa.com

1-800-PORSCHE