



PORSCHE



The Panamera
Thrilling Contradictions



Concept	6	Personality	83
The Panamera model range	8	Interior	84
Design	10	Communication	92
Interior	12	Sound systems	98
Engineering	14	Assistance systems	100
		Luggage compartment	109
Models	16	Individuality	110
Panamera and Panamera 4	18	Colours	113
Panamera S and Panamera 4S	24	Options	120
Panamera S E-Hybrid	30	Porsche Exclusive	138
Panamera GTS	38	Porsche Car Configurator	139
Panamera Turbo	44		
Performance	50	Porsche Driving Experience	140
Drive	53	Factory collection	141
Transmission	58	Panorama	142
Chassis	61	Summary	144
Balance	70	Technical data	146
Safety	73		
Environment	81	Index	154



Day and dream. Concept.

The dream of a sports car, but without compromise in terms of everyday driving. These claims couldn't really be further apart, yet the Panamera models incorporate them seamlessly. With a sporty saloon offering four seats and extraordinary comfort. Amalgamating the power of contradictions to create something utterly distinctive: a Porsche – for every day of the year.

Sometimes the most sensible thing to do is pursue an idea all the way to the top.

The Panamera model range.

In the beginning, there were doubters. Four in a sports car – and travelling in comfort? With luggage but without compromise? They said that would never work. But it does, as we now know. The Panamera gave the automotive executive class a new lease of life and silenced the doubters.

Job done, we could have said. But Porsche wouldn't be Porsche if we rested on our laurels. Over 30,000 racing victories could not have been achieved by us simply being good at what we do – but by us continuing to improve. We've increased our performance. We've enhanced our efficiency. We've reduced our fuel consumption. The same principle applies to the Panamera, because we create sports cars for every day.

The Panamera models have pushed the contradictions to the limit. With sporty dynamics and great efficiency, with impressive comfort and a typically Porsche design. For extraordinary driving pleasure on ordinary outings, on every inch of road.



Panamera S E-Hybrid with 20-inch Panamera Sport wheels, Panamera Turbo with 20-inch 911 Turbo II wheels

One of our most important design tools: timelessness.

Design.

When we style a sports car, we could focus on the here and now and follow the latest fashion. That would be fine until the next season arrives. But, how exactly do you create something that not only appeals today but also captivates tomorrow? We believe it's achieved by focusing on principles, by preserving the tried and tested and using this as the platform for new ideas.

With the Panamera models, the proportions and use of form are typical of any Porsche. The wings are higher than the bonnet and they add muscle at the rear.

The roof line tapers down to the rear. Another typical Porsche characteristic is the evolution of the design. It's more precise. Sharper. Edgier.

Visible examples include the enlarged air intakes in the front end. These help to provide optimum cooling of the engine and brakes. The fact that they also look great is a welcome bonus.

The rear end contouring is sharper. The rear screen larger, flatter and wider – as is the automatically deploying spoiler. The LED taillights have become narrower

and more crisply defined. Seen from the rear, the new Panamera models look more modern and boast tauter proportions.

Another illuminating example of the further development of the Panamera design is the headlights. The Panamera Turbo has LED main headlights including Porsche Dynamic Light System (PDLS) as standard, while Bi-Xenon main headlights are standard in the other models. The daytime running lights are integrated into the main headlight units in the form of four LED spotlights.

Together with the more distinctive powerdome on the bonnet, the sideskirts and exterior mirrors, they lend the Panamera models a more sporty look.

Traditional values and a forward-looking design make a successful combination. All that's missing is your own interpretation of the Panamera. With 16 exterior colours, an extensive range of leather packages, wheels measuring up to 20 inches and many more options, you can lend your model an unmistakable character.



Panamera 4 with 20-inch RS Spyder Design wheels, Panamera Turbo with 20-inch 911 Turbo II wheels



Interior of the Panamera Turbo in two-tone Black and Garnet Red, carbon interior package and other optional equipment

**To get on in life,
sometimes all you need to do is sit back and relax.**

Interior.

The Panamera models feature an exquisite, clearly structured interior offering a high degree of comfort. Designed for driving pleasure and long journeys, for four occupants and their luggage. The concept may be unorthodox for a saloon, but it's typical of a Panamera.

Of course, the same applies to the four individual seats. Just as it does to the sporty and highly ergonomic cockpit. Five round instruments with a high-resolution colour display and the logical grouping of controls enable fast and direct access.

In the rear, even taller passengers will find plenty of head- and legroom. The rear seats fold down separately to create space for larger items of luggage, including your sports equipment.

You choose the colours and materials yourself. An extensive selection of interior colours, interior packages with various woods, aluminium or carbon, and many other personalisation options means that your decision certainly won't be an easy one. But the result will be all the more individual. For more information, please refer to page 110 onwards.

Saving fuel needn't mean cutting back on the adrenaline.

Engineering.

Getting where you want to be sooner – whether it's your office or your holiday destination. More than likely, though, it's the future.

Typically for Porsche, it begins in the garage. Or, to be more specific, at the vehicle charge port of the Panamera S E-Hybrid – a parallel plug-in hybrid, and also the next major step in hybrid technology. The future begins now. With e-mobility. A total concept that combines a progressive drive system, a variety of charging capabilities, intelligent mobile online services and efficient performance.

The lithium-ion-based high-voltage battery of the Panamera S E-Hybrid has more energy content than nickel metal hydride batteries and can be charged from an external source. On electric power alone, the Panamera S E-Hybrid has a range of up to 36 km in the NEDC and reaches a maximum speed of 135 km/h. That's with an average fuel consumption of merely 3.1 l/100 km. However, reducing fuel consumption is just one of the goals that we are aiming to achieve with advanced hybrid technology. Everyday practicality and sporty driving pleasure are also top of our list. For more information on the

Panamera S E-Hybrid, please refer to page 30 onwards.

The engine in the Panamera S and Panamera 4S delivers high performance and economy. Thanks to some intelligent downsizing, the 3.0-litre twin-turbo V6 engine produces more power output than the naturally aspirated engine of the previous generation – and delivers a lower rate of fuel consumption at the same time.

Porsche Doppelkupplung (PDK, p. 58) is now fitted as standard in all models with a petrol engine. The power of the

Panamera S E-Hybrid is transmitted to the road by the 8-speed Tiptronic S.

Prepped and ready for the future of the automobile and the digital age – Porsche Car Connect (p. 100). Porsche Car Connect is a smartphone app that enables you to access various data relating to your car and control certain functions remotely. In conjunction with the comprehensive online services option, you can see all the important information about your Panamera whenever you wish – and not only when you're behind the wheel.

The optional LED main headlights (standard in the Panamera Turbo, p. 73–75) help to ensure even better visibility. And a whole host of other assistance systems are available, such as Lane Change Assist (p. 105), Lane Departure Warning (p. 105), speed limit indicator (p. 105), adaptive cruise control including Porsche Active Safe (PAS, p. 102) or Surround View (p. 102). Systems to lower your adrenaline level – on the odd occasion.

For fuel consumption, CO₂ emissions and efficiency class, please refer to page 150 onwards.



Panamera S E-Hybrid with Porsche Universal Charger (AC) and Charging Dock

What is it that actually matters when creating a sports car? The effect on the eye or the effect on physics? A stylish appearance or sense and purpose? We believe that, when form follows function, one emerges from the other. And style suddenly makes sense.



Beauty and sense. Models.

Who says that the head and heart cannot work together?

The Panamera and the Panamera 4.

Saloon or sports car? Power or efficiency? Quite simply, there's no decision to make. That's because the Panamera and the Panamera 4 blend all these apparent contradictions into one sporty overall concept.

Standard features of the Panamera and the Panamera 4 include Bi-Xenon main headlights, the 18-inch Panamera wheels, the two single-tube tailpipes of the exhaust system and the automatic rear hatch.

Both models are equipped with Porsche Doppelkupplung (PDK) as standard. In the Panamera, it transfers engine power to the rear axle; in the Panamera 4 to all four wheels via the active all-wheel drive of Porsche Traction Management (PTM, p. 61).

The steel spring suspension is fitted as standard and offers a high level of comfort coupled with a sporty setup. Porsche Active Suspension Management (PASM, p. 65), an electronic damping control system and the adaptive air suspension are available as an option.

The interior boasts high-quality materials, and the partial leather package is available in a choice of three colours. The rim of the multifunction steering wheel (p. 62) fitted as standard and the PDK gear selector are finished in smooth-finish leather, the interior trims in black (high-gloss).

Other standard features of the Panamera and Panamera 4 are cruise control (p. 102), Tyre Pressure Monitoring (TPM, p. 64), automatic climate control and the CDR audio system (p. 92). Options include Porsche Communication

Management (PCM, p. 92), and the BOSE® Surround Sound System (p. 98) or the Burmester® High-End Surround Sound System (p. 98).

A comprehensive range of personalisation options is available to you. These include, for example, a selection of two-tone finishes and other colour and material combinations (more on these from page 110 onwards).



Panamera with 18-inch Panamera wheels



Drive concept.

The efficient 3.6-litre naturally aspirated V6 engine with four overhead camshafts benefits from a lightweight construction. A balance shaft reduces vibrations and ensures excellent smooth running. Direct fuel injection (DFI, p. 53), VarioCam Plus (p. 54) and integrated dry-sump lubrication are fitted as standard. A coasting function (p. 54) and auto start/stop function (p. 54) are also provided.

The engine generates a power output of 228 kW (310 hp) at 6,200 rpm and a maximum torque of 400 Nm at 3,750 rpm. The result is a top speed of 259 km/h and acceleration from 0 to 100 km/h in 6.3 seconds in the Panamera, and a 257 km/h top speed and 6.1 seconds from 0 to 100 km/h in the Panamera 4.

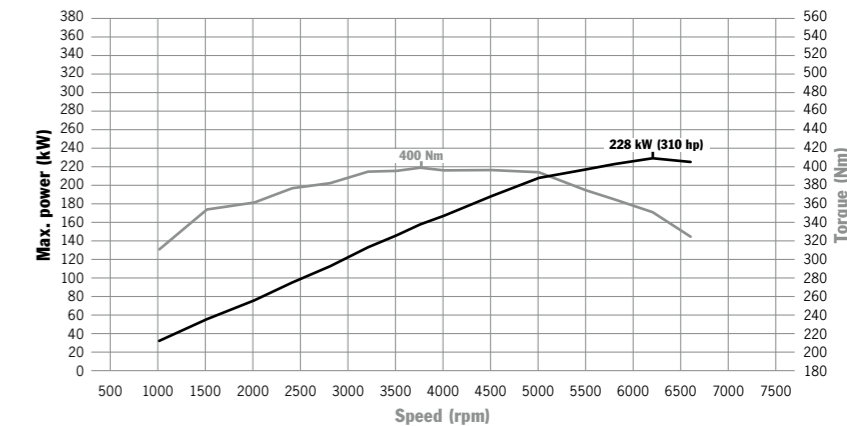

Panamera and Panamera 4: 228 kW (310 hp) at 6,200 rpm, 400 Nm at 3,750 rpm

For fuel consumption, CO₂ emissions and efficiency class, please refer to page 150.



Interior of the Panamera in Luxor Beige, dark walnut interior package and other optional equipment



Luggage compartment

Selected key features of the standard specification.

- Porsche Doppelkupplung (PDK) including auto start/stop function
- Porsche Stability Management (PSM)
- Bi-Xenon main headlights
- Multifunction steering wheel
- Partial leather interior
- CDR audio system
- Cruise control
- ParkAssist (front and rear)
- Tyre Pressure Monitoring (TPM)
- 18-inch Panamera wheels
- Automatic rear hatch

Technical data.

- 3.6-litre naturally aspirated V6 engine
 - 228 kW (310 hp)
- Panamera:
- 0–100 km/h in 6.3 secs
 - 259 km/h top speed
- Panamera 4:
- 0–100 km/h in 6.1 secs
 - 257 km/h top speed

For fuel consumption, CO₂ emissions and efficiency class, please refer to page 150.

**Of course, you could find other ways to get to the office.
But why should you?**

The Panamera S and the Panamera 4S.

Everyday driving requires practical cars with space and comfort. But doesn't your heart crave a sports car? We don't see a contradiction.

Both models are driven by a 3.0-litre V6 engine with twin-turbochargers. Engine power is transmitted by Porsche Doppelkupplung (PDK, p. 58). In the Panamera 4S it is distributed to all four wheels via the all-wheel drive of Porsche Traction Management (PTM, p. 61).

Bi-Xenon main headlights, including daytime running lights with four integral LED spotlights, are fitted as standard on all models. The same applies to Porsche Active Suspension Management (PASM, p. 65) – an electronic damping control system – and Tyre Pressure Monitoring (TPM, p. 64).

From the outside, the Panamera S models are recognisable by the silver-coloured brake calipers, 18-inch Panamera S wheels and the round twin tailpipes of the exhaust system.

In the interior, the rev counter dial face in Silver Grey is another hallmark. Automatic climate control and heated front seats are fitted as standard to provide excellent comfort. The partial leather interior is also standard. The seat squab surfaces, inner backrest surfaces and the inner side bolsters are all upholstered in embossed leather.

For fuel consumption, CO₂ emissions and efficiency class, please refer to page 150.





Drive concept.

Yes, power is important. Just as important as efficiency. That's why the Panamera S and the Panamera 4S have a 3.0-litre twin-turbo V6 engine. Thanks to some clever downsizing, the result is more power output than that of the naturally aspirated engine in the predecessor model, yet with significantly lower fuel consumption.

The lightweight construction of the engine also contributes to its high efficiency. Technologies such as direct fuel injection (DFI, p. 53), four overhead camshafts and VarioCam Plus (p. 54) join forces with twin-turbochargers to deliver a high degree of efficiency and optimum torque in every engine speed range.

The result is 309 kW (420 hp) at 6,000 rpm, 520 Nm between 1,750 and 5,000 rpm. The Panamera S completes the sprint from 0 to 100 km/h in 5.1 seconds and manages a top speed of 287 km/h. The Panamera 4S reaches 100 km/h from a standing start in 4.8 seconds and achieves a top speed of 286 km/h. And that's with up to 18% less fuel consumption than that of the respective predecessor model.

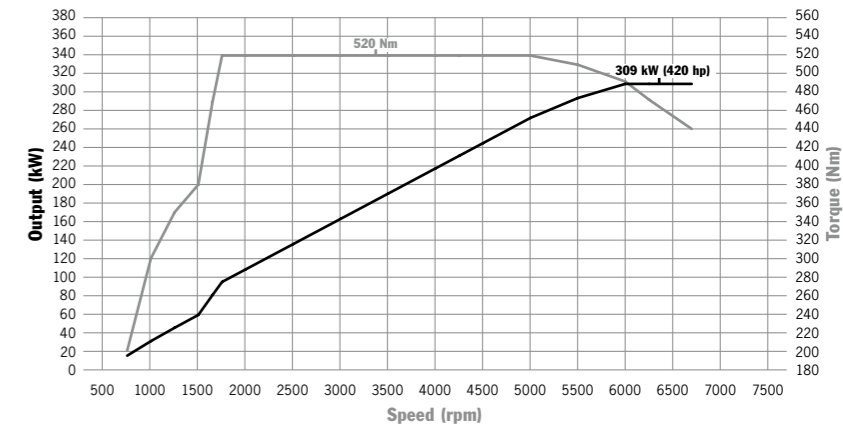

Panamera S and Panamera 4S: 309 kW (420 hp) at 6,000 rpm, 520 Nm between 1,750 and 5,000 rpm

For fuel consumption, CO₂ emissions and efficiency class, please refer to page 150.



Tailpipe covers of the exhaust systems on Panamera S models



Panamera S with 18-inch Panamera S wheels



Interior of the Panamera 4S in two-tone Agate Grey and Cream, anthracite birch interior package and other optional equipment

Selected key features of the standard specification.

- Porsche Doppelkupplung (PDK) including auto start/stop function
- Porsche Stability Management (PSM)
- Bi-Xenon main headlights
- Tyre Pressure Monitoring (TPM)
- Multifunction steering wheel
- Partial leather interior
- Seat heating (front)
- CDR audio system
- Cruise control
- ParkAssist (front and rear)
- Automatically dimming mirrors
- 18-inch Panamera S wheels
- Automatic rear hatch

Technical data.

- 3.0-litre twin-turbo V6 engine
 - 309 kW (420 hp)
- Panamera S:
- 0–100 km/h in 5.1 secs
 - 287 km/h top speed
- Panamera 4S:
- 0–100 km/h in 4.8 secs
 - 286 km/h top speed

For fuel consumption, CO₂ emissions and efficiency class, please refer to page 150.

Still one of the most fascinating destinations of any journey: new territory.

The Panamera S E-Hybrid.

Many roads lead to your destination. But which ones take you further? To a new future? With a sports car for the road and for the 21st century?

E-mobility is the next big step. With the Panamera S E-Hybrid we are bringing to the road a total concept that networks the car and its driver in an intelligent way. Its performance puts most sports cars to shame. Yet its fuel consumption is far below the rate you would usually expect of a sports car.

In the Panamera S E-Hybrid, innovative battery technology and a powerful electric motor herald a little revolution in alternative drives: driving pleasure. We round off our concept with practical solutions, which we've realised with E-Mobility Services* – smartphone access and control functionalities – and with practical charging systems. Now you can top up your car's energy levels by plugging it into an electrical socket using the Porsche Universal Charger (AC) provided as standard. For an all-electric range of up to 36 km (in NEDC). You will find more information about the drive

concept, charging options and E-Mobility Services in our separate e-mobility brochure.

Drive forces are transmitted, as standard, by the 8-speed Tiptronic S (p. 58). Also fitted as standard are the adaptive air suspension with Porsche Active Suspension Management (PASM, p. 65) and the speed-sensitive Power steering Plus (p. 62).

The Panamera S E-Hybrid maintains its visual identity with the customary 'e-hybrid' logo on the front doors, the

'Panamera S' logo on the rear hatch with an Acid Green surround, the same as the needles of the newly developed power meter in the centre of the instrument cluster. The brake calipers are also finished in Acid Green as standard. The features it shares with the Panamera S models – the exterior design and the exquisite styling of the interior – are similarly characteristic. It almost goes without saying that a comprehensive range of personalisation options is available. These are listed from page 110 onwards.

* Not available in all countries.



Panamera S E-Hybrid with 20-inch Panamera Sport wheels





Drive concept.

The Panamera S E-Hybrid is a parallel plug-in hybrid. This means that it can be powered by the combustion engine alone, by the electric machine alone or by both units working together. In this way, it is able to exploit the power generated by both propulsion units – a concept that's been proven since 2011. The high-voltage battery is recharged in around 2.3 hours from an industrial electrical outlet. Or whilst driving, by recuperation – brake energy recovery – or via the combustion engine. Thanks to innovative lithium-ion technology, its capacity of 9.4 kWh means that it also stores much more energy. The battery is maintenance-free and covered by a six-year warranty (up to a maximum of 120,000 km).

The 3.0-litre supercharged V6 engine generates 245 kW (333 hp), the electric motor 70 kW (95 hp). Combined, they deliver 306 kW (416 hp) to the road at

5,500 rpm. With both drives working together, the Panamera S E-Hybrid accelerates from 0 to 100 km/h in a mere 5.5 seconds. Fuel consumption (NEDC) is remarkably low at an average of 3.1 l/100 km, as is the CO₂ emissions figure of 71 g/km.

The operating range of the hybrid drive begins with emission-free, quiet driving up to a maximum speed of around 135 km/h and a range of approximately 36 km (in NEDC). The combustion engine is fired automatically when necessary as determined by the operating strategy or actively in response to the driver depressing the accelerator pedal beyond a specially defined pressure point. The kick-down point, however, enables the maximum power output available from both propulsion units to be purposefully

exploited as and when the driver chooses. In e-boost mode, the combustion engine provides assistance for the electric drive – providing a sporty shunt into the future. In coasting mode, the combustion engine is decoupled to allow the car to glide for some distance under its own momentum – thereby further reducing the fuel consumption.

In summary, the E-Hybrid concept promises one thing above all: sporty performance with utmost efficiency. The workings of the combustion engine, electric motor and high-voltage battery are synchronised by the electronic engine management. All processes run smoothly and harmoniously, leaving you to concentrate on what matters the most: driving.

For fuel consumption, CO₂ emissions, power consumption and efficiency class, please refer to page 151.

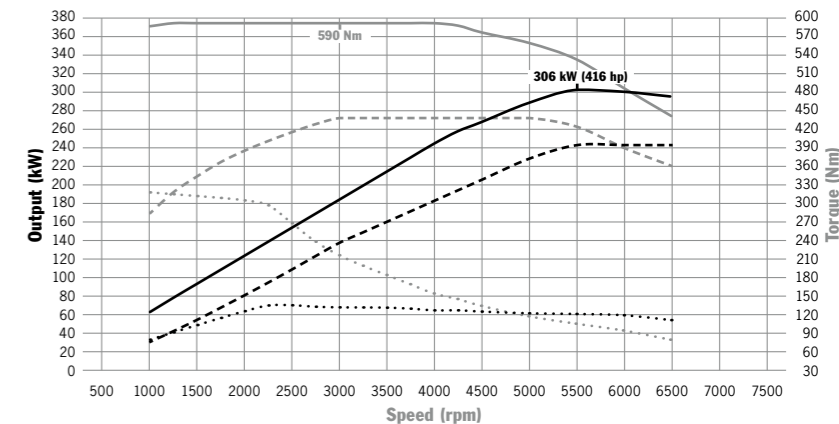

- Panamera S E-Hybrid combined:
306 kW (416 hp) at 5,500 rpm, 590 Nm between 1,250 and 4,000 rpm
- Panamera S E-Hybrid electric machine:
70 kW (95 hp) between 2,200 and 2,600 rpm, 310 Nm < 1,700 rpm
- - - Panamera S E-Hybrid combustion engine:
245 kW (333 hp) between 5,500 and 6,500 rpm, 440 Nm between 3,000 and 5,250 rpm

Display concept.

The conventional analogue speedometer in the instrument cluster – traditionally to the left of the rev counter – is replaced by a solution that is fully tailored to the Panamera S E-Hybrid. The power meter displays the drive power of the system. It tells you whether your Panamera S E-Hybrid is being driven electrically or in hybrid mode and informs you of the recuperation power generated under braking. The colour display in the instrument cluster shows the energy flow in the system as well as selected driving statistics.

In the optional Porsche Communication Management (PCM, p. 92) you can view at any time a detailed diagram of the vehicle with energy flow and statistics on the amount of driving without the combustion engine.

E-Mobility Services.

E-Mobility Services* are part of the optional Porsche Car Connect (p. 100). They enable you to call up all the important information about your Panamera S E-Hybrid remotely via a smartphone app, for example remaining charge time, battery charge status or a visual depiction of the electric range.

You can also set a charge timer with a customisable start time.

You can now even control the air conditioning of your Panamera S E-Hybrid from your smartphone as desired. In this way, it is possible to heat or cool the interior in advance of any journey – with the vehicle stationary and the combustion engine switched off. Thanks to E-Mobility Services and your smartphone, you can also locate your Panamera S E-Hybrid at any time from any place.

You will find detailed information about e-mobility at www.porsche.com or in our separate e-mobility brochure.

* Not available in all countries.

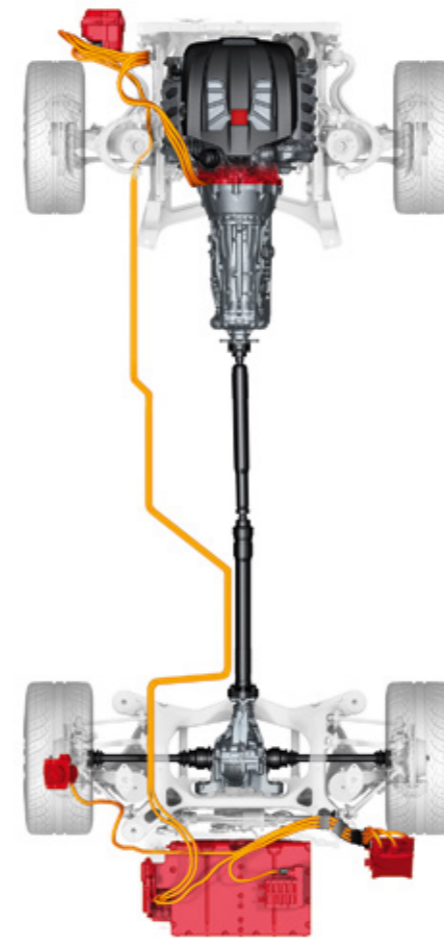

Hybrid components of the Panamera S E-Hybrid



Panamera S E-Hybrid instrument cluster



Display of the energy flow in the optional Porsche Communication Management (PCM)



Panamera S E-Hybrid interior in Marsala, brushed aluminium interior package and other optional equipment



E-POWER and E-CHARGE button



'e-hybrid' logo on the doors

Selected key features of the standard specification.

- Porsche Universal Charger (AC) including carrying case, two mains cables and a basic wall mount
- Porsche Car Connect E-Mobility Services
- 8-speed Tiptronic S
- Adaptive air suspension including Porsche Active Suspension Management (PASM)
- Porsche Stability Management (PSM)
- Bi-Xenon main headlights
- Tyre Pressure Monitoring (TPM)
- Power steering Plus
- Multifunction steering wheel
- Partial leather interior
- Seat heating (front)
- CDR audio system
- Cruise control

- ParkAssist (front and rear)
- Automatically dimming mirrors
- Rear wiper
- 18-inch Panamera S wheels
- Automatic rear hatch

Technical data.

- Combined 306 kW (416 hp) at 5,500 rpm
- electric motor 70 kW (95 hp)
- combustion engine 245 kW (333 hp)
- 0–100 km/h in 5.5 secs
- 270 km/h top speed
- 135 km/h top speed (electric)
- 9.4 kWh lithium-ion battery
- Charging time:
 - 3.8 h from a domestic socket (EU)
 - 2.3 h from an industrial electrical outlet

For fuel consumption, CO₂ emissions, power consumption and efficiency class, please refer to page 151.

How about some extra zing?

The Panamera GTS.

The Panamera models reconcile contradictions. They are vitalised by the conflict between comfort and dynamics and between sporty performance and efficiency. Can three letters intensify this conflict? The answer is seen on racetracks and on roads. That's where Porsche has written the abbreviation GTS into history – and is how the Panamera GTS has become the thoroughbred athlete of the family.

The figures sum it up: 324 kW (440 hp) power output and a maximum torque of 520 Nm. The 4.8-litre naturally aspirated

V8 engine with ram induction is extremely responsive. 7-speed Porsche Doppelkupplung (PDK) and the active all-wheel drive of Porsche Traction Management (PTM) transmit the engine power of the Panamera GTS adeptly to the tarmac. The sports exhaust system and the adaptive air suspension with 'normal level' lowered by 10 mm are fitted as standard. The brake system, wheels, front end and four-way rear spoiler have been carried over from the Panamera Turbo. The sideskirts are styled in matt black.

This is driving pleasure the GTS way – accompanied by a thunderous soundtrack.

The sporty characteristics of the Panamera GTS continue seamlessly into the interior in the form of leather and Alcantara and the carbon interior package, the 'GTS' logo in the rev counter, on the headrests and on the door sill guards in brushed aluminium. Alcantara is the material used for the seat centres of the adaptive Sports seats, the armrests of the centre console and the roof lining. The

SportDesign steering wheel is fitted as standard. On request, it is possible to have the rim finished in black Alcantara.

Two optional trim packages are available in conjunction with the black Alcantara. They further emphasise the sporty attitude of the interior. The edges of the seat belts and the stitching on the dashboard, door waist rails, seats, and the armrests on the centre console and doors are in Carmine Red or GT Silver. The headrests of all four seats are embroidered with the 'GTS' logo in the same colour.



Panamera GTS with 20-inch RS Spyder Design wheels

For fuel consumption, CO₂ emissions and efficiency class, please refer to page 151.



Drive concept.

The Panamera GTS is driven by a 4.8-litre V8 engine of lightweight construction with integrated dry-sump lubrication. As a naturally aspirated unit, it inherently delivers a remarkably direct response. The maximum engine speed is 7,100 rpm. The result is a compelling 324 kW (440 hp) and 520 Nm.

Features specific to the new Panamera GTS include intake camshafts with great valve lift and a new air induction system with two additional air filter modules in the front end. At 3,500 rpm, the flaps on the air filter modules are opened to allow the engine to breathe more easily. At high driving speeds, headwind ram pressure is exploited for an extra boost.

The modified engine management has also been fully adapted to the Panamera GTS with the focus on maximum performance. For a more direct response characteristic and even faster gear changing of the PDK (p. 58). You'll certainly feel it every time you open the throttle. The Sport Chrono Package is integrated as standard. In SPORT PLUS mode, the race from 0 to 100 km/h lasts a mere 4.4 seconds. The top speed is 288 km/h. The figures speak for themselves – and for pure sports performance.

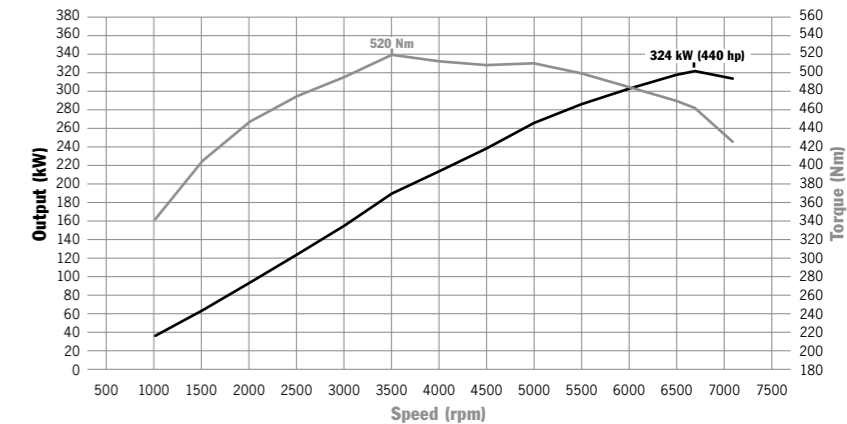

Panamera GTS: 324 kW (440 hp) at 6,700 rpm, 520 Nm at 3,500 rpm

For fuel consumption, CO₂ emissions and efficiency class, please refer to page 151.



Panamera GTS interior in black, Carmine Red GTS interior package, carbon interior package and other optional equipment



Panamera GTS with 20-inch RS Spyder Design wheels



Tailpipes of the sports exhaust system in black

Selected key features of the standard specification.

- Porsche Doppelkupplung (PDK) including auto start/stop function
- Bi-Xenon main headlights in black including Porsche Dynamic Light System (PDLS)
- Porsche Traction Management (PTM) active all-wheel drive
- Adaptive air suspension (normal level -10 mm) including Porsche Active Suspension Management (PASM)
- Panamera Turbo brake system with red brake calipers
- SportDesign steering wheel with gearshift paddles
- Sports exhaust system with tailpipes painted in black
- Sport Chrono Package
- ParkAssist (front and rear)
- Leather interior package with selected items in Alcantara

- Carbon interior package
- Adaptive Sports seats including memory package
- Adaptive rear spoiler (four-way)
- Tyre Pressure Monitoring (TPM)
- 19-inch Panamera Turbo II wheels with 5 mm spacers at rear axle

Technical data.

- 4.8-litre naturally aspirated V8 engine
- 324 kW (440 hp)
- 0-100 km/h in 4.4 secs
- 288 km/h top speed

For fuel consumption, CO₂ emissions and efficiency class, please refer to page 151.

**520 hp unleashes a mighty force.
The kind to put a smile on your face.**

The Panamera Turbo.

Supreme performance can take your breath away. Or it can force you to keep calm and breathe deeply. It's like sitting behind the wheel of the Panamera Turbo.

Here, comfort and sportiness intertwine without compromise. Its 4.8-litre twin-turbo V8 engine delivers 382 kW (520 hp) and offers a maximum torque of 700 Nm between 2,250 and 4,500 rpm. The 19-inch Panamera Turbo II wheels afford a glimpse of the brake system and its red brake calipers.

The twin dual-tube tailpipes are in the unmistakable Turbo design. Just like the chrome-coloured air outlets behind the front wheels.

The front end features large air intakes to increase the volume of cooling air, while the four-way rear spoiler helps to reduce lift at the rear axle.

Porsche Doppelkupplung (PDK, p. 58) is fitted as standard, as is Porsche Traction Management (PTM, p. 61) with active all-wheel drive and an electronic and map-

controlled multi-plate clutch. Integrated as standard, the adaptive air suspension including Porsche Active Suspension Management (PASM, p. 65) enhances sporty performance – or comfort. At the push of a button. Excellent illumination of the road is provided by the LED main headlights including Porsche Dynamic Light System (PDLS, p.73).

In the interior, the Turbo presents its own interpretation of the sporty style that characterises any Porsche. It achieves this with comfortable, electrically

adjustable seats at the front with memory package (p. 88) and seat heating (p. 91) for the driver, front passenger and also in the rear; and with an interior in smooth-finish leather and the dark walnut interior package. Porsche Communication Management (PCM) including navigation module and BOSE® Surround Sound System (p. 98) are fitted as standard. The High-End Surround Sound System from Burmester® (p. 98) is available as an option.

For fuel consumption, CO₂ emissions and efficiency class, please refer to page 151.



Panamera Turbo with 20-inch 911 Turbo II wheels





Drive concept.

The Panamera Turbo is powered by a 4.8-litre twin-turbo V8 engine with direct fuel injection (DFI, p. 53), VarioCam Plus (p. 54) and charge-air cooling. It features two turbochargers arranged in parallel – one for each cylinder bank. Intake air is compressed and then fed to the engine by the respective charge-air cooler for each cylinder strand.

Performance figures: 382 kW (520 hp) at 6,000 rpm. The maximum torque of 700 Nm is achieved between 2,250 and 4,500 rpm. Top speed is reached at 305 km/h. The Panamera Turbo completes the sprint from 0 to 100 km/h in just 4.1 seconds.

With the Launch Control function of the optional Sport Chrono Package (p. 68), the clock stops even sooner at 3.9 seconds. An overboost function temporarily increases the boost pressure produced at full throttle by up to 10%. Proof that supremacy is synonymous with sheer fun.

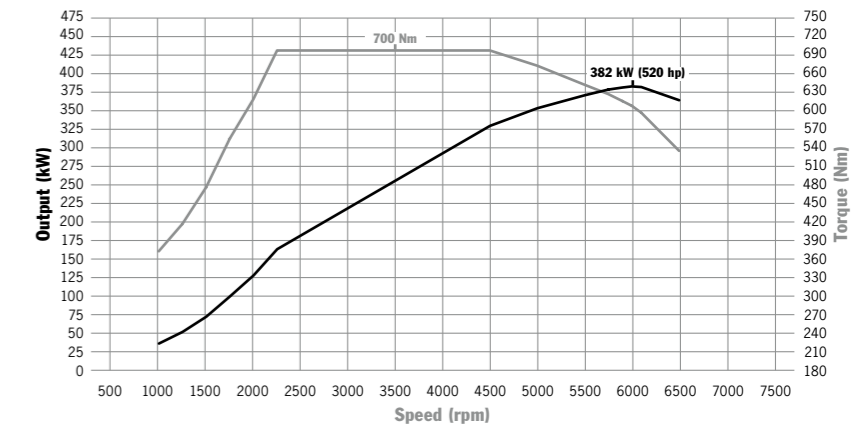

Panamera Turbo: 382 kW (520 hp) at 6,000 rpm, 700 Nm between 2,250 and 4,500 rpm

For fuel consumption, CO₂ emissions and efficiency class, please refer to page 151.



Rear spoiler deployed



Panamera Turbo with 19-inch Panamera Turbo II wheels



Panamera Turbo interior in two-tone Black and Garnet Red, carbon interior package and other optional equipment

Selected key features of the standard specification.

- Porsche Doppelkupplung (PDK)
- Adaptive air suspension including Porsche Active Suspension Management (PASM)
- Porsche Traction Management (PTM) active all-wheel drive
- Porsche Communication Management (PCM)
- 19-inch Panamera Turbo II wheels
- LED main headlights including Porsche Dynamic Light System (PDLS)
- Porsche Entry & Drive
- ParkAssist (front and rear)
- Eight-way power seats including memory package
- Seat heating (front and rear)
- BOSE® Surround Sound System
- Leather interior package in smooth-finish leather
- Dark walnut interior package

Technical data.

- 4.8-litre twin-turbo V8 engine
- 382 kW (520 hp)
- 0–100 km/h in 4.1 secs
- 305 km/h top speed

For fuel consumption, CO₂ emissions and efficiency class, please refer to page 151.

Driving a sports car is fun. But do our own principles have to fall by the wayside? Those who are serious about performance potential don't evade questions of efficiency. They answer them by showing the same will to perform.



Pleasure and principle. Performance.



3.0-litre twin-turbo V6 engine

1. Throttle bodies/electronic throttle
2. Intake manifold
3. Intake camshaft
4. Exhaust camshaft
5. VarioCam Plus (valve adjuster)
6. VarioCam Plus (switching tappet)
7. Valve
8. Exhaust manifold
9. Turbocharger
10. Poly-V belts
11. PDCC/power steering pump
12. Air-conditioning compressor
13. Oil/water heat exchanger
14. Oil filter

**We can make things move in many ways.
With lightness, for example.**

Drive.

Engines.

Increasing power output, reducing fuel consumption. With engines characterised by sporty performance and yet comparatively low energy consumption and CO₂ emissions.

This has been achieved thanks to technologies such as direct fuel injection (DFI), VarioCam Plus or variable camshaft control, turbocharging, recuperation, the auto start/stop function, the coasting function or the use of plug-in hybrid technology. The engines are structurally rigid and, thanks to aluminium cylinder heads and magnesium valve covers

(except the Panamera S E-Hybrid), they are comparatively lightweight. This helps to ensure a decent weight-to-power ratio and balanced weight distribution.

Let's take the current engine generation of the Panamera S and Panamera 4S as an example. It may have been stripped of two cylinders and its displacement reduced by 1.8 litres compared with that of the previous generation, but it has been given a twin-turbocharger arrangement. This is where the figures begin an upward trend. Increased power output, greater dynamics and enhanced efficiency.

Direct fuel injection (DFI).

With millisecond precision, DFI injects fuel at up to 120 bar directly into the combustion chamber by means of electromagnetically actuated injection valves. DFI also improves the internal cooling of the combustion chamber by having the mixture prepared directly in the cylinder. The higher compression ratio helps to deliver more output at the same time as enhanced engine efficiency.

VarioCam Plus.

VarioCam Plus is a two-in-one engine concept for adjusting the intake and exhaust camshafts and switching the lift of the intake valves. The system differentiates between driver inputs that typify normal, everyday driving and those inputs that demand maximum power.



VarioCam Plus

Valve operation is then adapted automatically to prevailing conditions. This results in instant acceleration and extremely smooth running as well as extraordinary acceleration power with comparatively low fuel consumption.

Standard in the Panamera models with petrol engine (except the Panamera S E-Hybrid).

Variable camshaft control.

In the V6 combustion engine of the Panamera S E-Hybrid, fully variable camshaft control is used to adjust the intake camshaft timing. The result is high specific output and high torque – even at low engine speeds.

Auto start/stop function.

The auto start/stop function switches off the engine as you approach a stopping situation. This fuel-saving system restarts the engine the moment you release the brakes.

All audio and communication systems remain switched on and automatic climate control continues to maintain your selected temperature, despite the engine being switched off. The engine restarts automatically if the energy needs of the auxiliary equipment can no longer be met by the energy saved in the battery. In all models (except the Panamera S E-Hybrid), the auto start/stop function can be activated and deactivated using a separate button.

Coasting.

The coasting function available with Porsche Doppelkupplung (PDK) enables you to save even more fuel where the situation allows.* The engine is decoupled from the transmission to prevent deceleration caused by engine braking. The Panamera S E-Hybrid goes one step further and switches off the engine completely. In this way, optimum use is made of the vehicle's momentum, allowing it to coast for longer distances. This achieves a noticeable reduction in fuel consumption with no impact on comfort or sporty performance.

* Not for Panamera GTS.





Panamera 4S with sports exhaust system

Lightweight exhaust system.

The exhaust system of the Panamera models is made from long-life stainless steel. The primary and main catalytic converters heat up rapidly and help to deliver effective emissions control. At high revs and under maximum

engine load, the exhaust system of the Panamera Turbo opens flaps for increased throughput and an even more thunderous sound.

Sports exhaust system.

Available as an option for the Panamera, Panamera 4, Panamera S, Panamera 4S and Panamera Turbo is a sports exhaust system featuring unique design tailpipe trims. For an even more authentic sports car sound – at the push of a button.

The tailpipes of the Panamera GTS sports exhaust system have a matt black painted finish as standard. At the touch of a button or when SPORT or SPORT PLUS mode is enabled, the sports exhaust system provides that characteristic motorsport sound – another unmistakable expression of the individuality of the Panamera GTS.



Panamera and Panamera 4 tailpipes



Panamera Turbo tailpipes

Race bred performance, refined for the road.

Transmission.

Porsche Doppelkupplung (PDK).

Offering both a manual gearshift and an automatic mode, 7-speed PDK promises to deliver sports performance with efficiency and comfort as well as rapid gear changes with no discernible interruption in the flow of power.

PDK is essentially two gearboxes in one. The double clutch provides an alternating, friction-locked connection between these two half gearboxes and the engine. Gears one to six have a sports ratio and top speed is reached in sixth gear. The seventh gear has a long ratio, which helps to keep the engine revs low, even at high speeds. Depending

on the gearshift programme (SPORT button activated or deactivated), the gear change is optimised for comfort or sporty driving.

For the Panamera GTS, we've made PDK even sportier. The gearshift programmes (Normal, SPORT or SPORT PLUS) configure the gear changes to be sporty to extremely sporty. During an upshift, for example, selected engine cylinders are deactivated temporarily, which enables the speed of the engine to be synchronised with the speed of the transmission more quickly. This results in even faster shift times accompanied by a characteristic motorsport engine sound.

8-speed Tiptronic S.

8-speed Tiptronic S in the Panamera S E-Hybrid reduces fuel consumption and improves comfort. How? With a particularly wide gear ratio spread. The relatively low engine speeds in the upper gears reduce noise levels in the interior, especially on the motorway. The 8-speed Tiptronic S shifts automatically and adapts to your driving style. Of course, you can still change gear manually at the gear selector itself or using the two ergonomic gearshift switches on the steering wheel.



Multifunction steering wheel, Sport Chrono Package



PDK gear selector

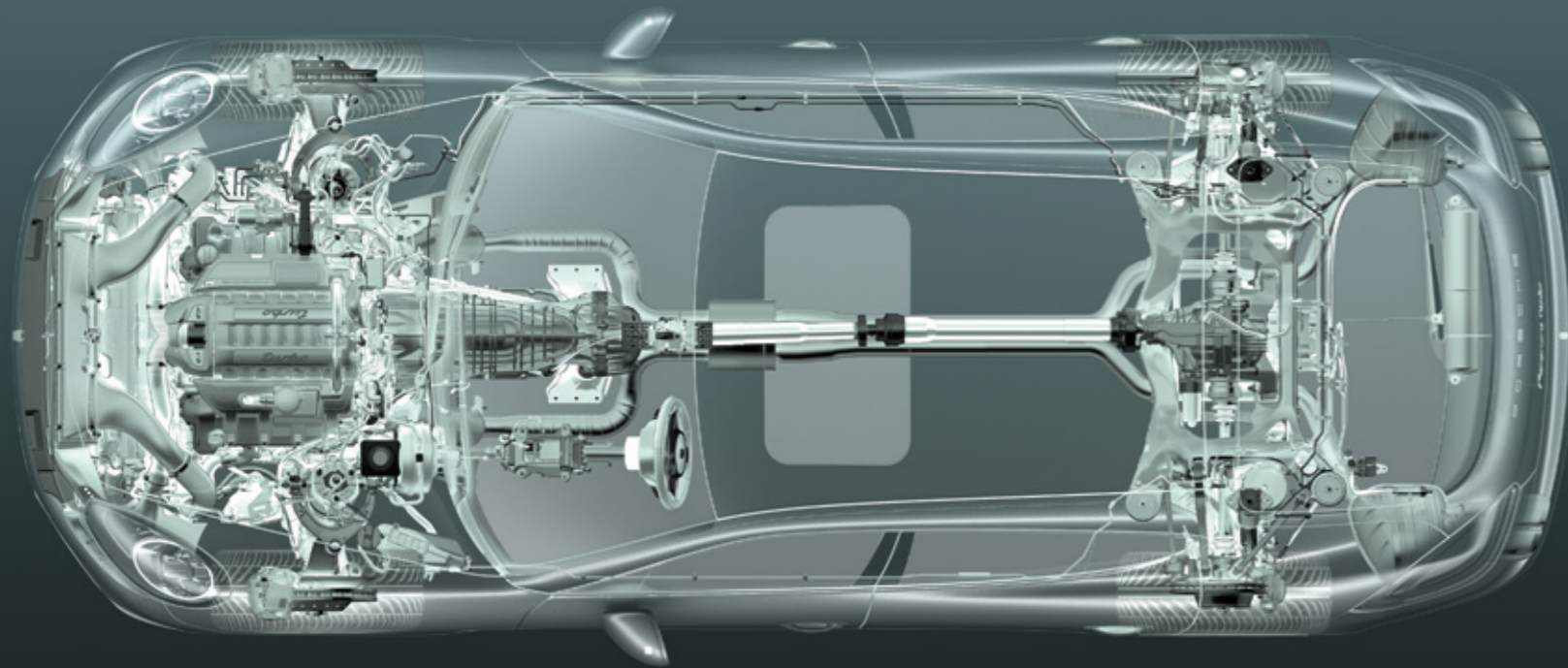

Active all-wheel drive

Exerting your authority. Letting go. Providing balance.
Typical powers of management.

Chassis.

Porsche Traction Management (PTM). Porsche Traction Management (PTM) comprises an active all-wheel drive with electronic and map-controlled multi-plate clutch, with automatic brake differential (ABD) and anti-slip regulation (ASR).

The electronically controlled multi-plate clutch regulates the distribution of drive force between the permanently driven rear axle and the front axle. The driving conditions are continuously monitored.

The electronics can then respond to a variety of situations. Sensors check, among other variables, the rotation speeds of all four wheels, longitudinal and lateral acceleration of the vehicle, and the steering angle. If, for example, the rear wheels spin under acceleration, a greater proportion of drive force is redirected to the front by a more powerful engagement of the multi-plate clutch. In addition, ASR reduces wheel slip. In corners, the drive force sent to the front wheels is regulated for optimum lateral stability.

In this way, in conjunction with Porsche Stability Management (PSM, p. 67), PTM ensures optimum force delivery in every driving situation and excellent acceleration power: whether on long straights, through tight corners, or on road surfaces with varying grip.

Standard in the Panamera 4, Panamera 4S, Panamera GTS and Panamera Turbo.

**We haven't reinvented the wheel.
Just about everything else that goes with it.**

Steering and Power steering Plus.

The steering system with its variable steering ratio is precise and direct. Around the straight ahead position, such as when on the motorway, the ratio is less direct with no loss of agility or feedback from the road. When the steering wheel is turned further, the steering ratio becomes more direct, allowing easier cornering and parking. For even greater driving comfort, speed-sensitive Power steering Plus is available as an option. At high speeds, the firmer steering ratio enables precision steering manoeuvres; at low speeds, the ratio automatically adjusts to facilitate parking.

Power steering Plus is standard in the Panamera S E-Hybrid and available as an option for the other Panamera models.

Steering wheels.

The multifunction steering wheel is standard in all models and available on request for the Panamera GTS – at no extra cost. It features two ergonomic gearshift switches for manual gear selection and offers convenient control of audio, telephone and navigation functions as well as the on-board computer. In conjunction with PDK and the Sport Chrono Package (p. 68), you will find an additional display above the

airbag module for the SPORT and SPORT PLUS modes and the Launch Control function.

The SportDesign steering wheel with gearshift paddles is fitted as standard in the Panamera GTS and available as an option for all other models. It is distinguished by its striking dual-arm design. Upon request, it is possible to have the SportDesign steering wheel finished in black Alcantara.



SportDesign steering wheel



Multifunction steering wheel





19-inch Panamera Turbo II wheel

Wheels and Tyre Pressure Monitoring (TPM).

The Panamera and Panamera 4 are fitted, as standard, with 18-inch Panamera wheels, the Panamera S, 4S and Panamera S E-Hybrid with 18-inch Panamera S wheels. The wheels on all models are lightweight alloys featuring a classic sporty design. Tyre sizes 245/50 ZR 18 and 275/45 ZR 18 are fitted to the front and rear, respectively. The Panamera GTS and Panamera Turbo are equipped with 19-inch Panamera Turbo II wheels as standard. The tyre

sizes are 255/45 ZR 19 at the front, 285/40 ZR 19 at the rear. A range of optional 19- and 20-inch wheels is also available (p. 128/129). In addition, all-season tyres are optionally available for all 19- and 20-inch wheels.

Tyre Pressure Monitoring (TPM) sends warnings to the on-board computer's display screen in the event of excessive pressure loss.

TPM is standard in all Panamera models.

Do you love the road? Keep your relationship intimate.

Porsche Active Suspension Management (PASM).

PASM is an electronic damping control system and it actively and continuously adjusts the damping force on each wheel, based on road conditions and driving style. This reduces body movement and therefore increases comfort in all four seats.

How does PASM work? By means of a button on the centre console, you can select one of the three modes: Comfort, SPORT or SPORT PLUS. Sensors record

the body movements that accompany powerful acceleration, braking and rapid cornering or uneven road surfaces. The control unit evaluates the driving conditions and modifies the damping force on each of the wheels in accordance with the selected mode. You can feel the result: increased driving stability, more comfort and improved performance.

Optional for the Panamera and Panamera 4, standard in all other models.

Adaptive air suspension.

Adaptive air suspension enhances both driving dynamics and comfort at the same time. It comprises a levelling system, a manual lift function, ride-height adjustment capability and the ability to vary the spring rate.

The purpose of the levelling system is to keep the vehicle level constant automatically, regardless of load distribution. For manoeuvring, the manual lift function enables you to raise the vehicle body by 20 mm to avoid the risk of grounding.

When you select the SPORT PLUS chassis programme, the ride height drops to 'low level' (–25 mm, or –15 mm in the Panamera GTS). At the same time, a harder spring rate is achieved through a reduction in the amount of air stored in the air suspension. In simple terms, it's a sports chassis at the push of a button.

Standard for the Panamera S E-Hybrid, Panamera GTS and Panamera Turbo, optional for the other models.



18-inch Panamera wheel



18-inch Panamera S wheel



Rapid cornering without PDCC (illustrative example)



Rapid cornering with PDCC (illustrative example)



**The more stable the relationship,
the greater your individual freedom.**

Porsche Dynamic Chassis Control (PDCC) including Porsche Torque Vectoring Plus (PTV Plus).

Porsche Dynamic Chassis Control (PDCC) is an active anti-roll system that anticipates and reduces lateral body movement during cornering manoeuvres. In addition, it minimises the lateral instability of the vehicle on uneven ground.

PTV Plus – in combination with PDCC – enhances driving dynamics as well as stability. As a function of steering angle and steering speed, accelerator pedal position, yaw rate and vehicle speed, it

is able to improve steering response and steering precision by specific braking of the right or left rear wheel.

What do PDCC and PTV Plus mean for you? Remarkable lateral stability and easier handling, excellent traction, and great agility at every speed with precise steering and stable load transfer characteristics. And even more fun in the corners.

Optional for the Panamera models (except Panamera S E-Hybrid).

Porsche Stability Management (PSM). PSM maintains stability even at the limits of dynamic driving performance. Sensors continuously monitor the direction, speed, yaw velocity and lateral acceleration of the car. PSM improves traction under acceleration on inconsistent road surfaces. When SPORT PLUS mode is selected on the Sport Chrono Package (p. 68), the PSM intervention threshold is raised to give sporty drivers greater freedom to assert their own driving style.

Standard in all Panamera models.

It used to be the timetable that decided the sports period. Now it's your turn.

Performance enhancement systems.

SPORT button.

The SPORT button, which is fitted as standard, enables you to select a setup that favours either comfort or sporty performance. At the push of a button, the electronic engine management system switches the engine mapping to offer a sharper response and engine dynamics that are more direct.

With the gearbox in automatic mode, upshifts take place at higher engine speeds and downshifts are swifter. In addition, Porsche Active Suspension

Management (PASM) and Porsche Dynamic Chassis Control (PDCC) also switch to SPORT mode to deliver harder damping and more direct steering and, therefore, even more agile cornering.

Sport Chrono Package.

The Sport Chrono Package helps to provide an even sportier setup. Included in the package are a digital and analogue stopwatch, the SPORT PLUS button, the longitudinal and lateral acceleration display and a performance display for displaying lap times in the PCM (p. 92).

The SPORT PLUS button on the centre console is used to activate SPORT PLUS mode. The engine becomes even more responsive. The rev-limiter is adjusted to a harder setting (except in the Panamera S E-Hybrid). Vehicles with Porsche Active Suspension Management (PASM) switch to SPORT PLUS mode for harder damping and more direct steering. Models with adaptive air suspension drop to 'low level' and switch to a stiffer spring rate. In SPORT PLUS mode, the trigger threshold for PSM is raised for increased longitudinal and lateral dynamics.

The stopwatch mounted on the dashboard displays recorded driving time or can be used as a conventional clock. Porsche Communication Management (PCM) has a special performance display to view, store and evaluate lap times or other driving times.

When combined with PDK, the Sport Chrono Package has two additional functions: the shift times in SPORT PLUS mode become even shorter, the gear changes even sportier. The second function is Launch Control, designed to

produce optimum acceleration from a standing start.

For the Panamera Turbo, increased power output is a matter of principle. In this model, the Sport Chrono Package takes performance to another level with the overboost function. Whenever you accelerate at full throttle in SPORT or SPORT PLUS mode, boost pressure will be temporarily increased by up to 10%. This significantly increases the maximum torque, delivers a short-term complacent 700 to 770 Nm – and puts a smile on the driver's face.

Standard in the Panamera GTS, optional for the other Panamera models and only in conjunction with Porsche Communication Management (PCM).

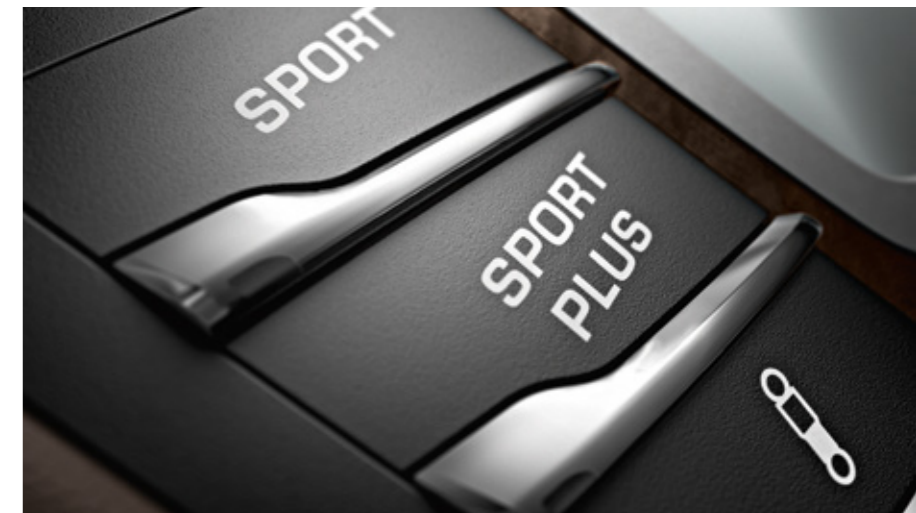

SPORT buttons on the centre console



Digital and analogue stopwatch on the dashboard



Calm and pulse. Balance.

At Porsche, intelligent engineering is also key to providing balance, especially behind the steering wheel. On long straights or in tight corners, with lighting systems, for example, that enable the driver to breathe easily regardless of the road ahead. With brake systems that contribute to the driver's inner calm and assistance systems that offer support rather than take over, as you will discover from page 100 onwards.



Night light design of the Bi-Xenon main headlights



Night light design

Sometimes, looking ahead also means thinking about what's around the next corner.

Safety.

Lighting concept.

A standard feature of the Panamera Turbo is the LED main headlights including Porsche Dynamic Light System (PDLS). More details on LED main headlights can be found on the following double-page spread.

The other Panamera models are equipped, as standard, with Bi-Xenon main headlights, including integrated daytime running lights, each with four LED spotlights. Porsche Dynamic Light System (PDLS) is included for the Panamera GTS. The headlight units can also be finished in black.

Automatic headlight activation is standard in all models and switches the lights on automatically when it starts to get dark, and switches them off automatically too. The 'Welcome Home' function switches on the daytime running lights and the taillights for a user-defined period, for example to light the way to your front door.

Adaptive LED brake lights are fitted as standard and pulsate in the event of panic braking, thereby alerting following traffic more quickly to a critical situation.

Porsche Dynamic Light System.

The Porsche Dynamic Light System (PDLS) is standard in the Panamera Turbo and Panamera GTS, and available on request for the other models.

Its dynamic cornering light function swivels the main headlights towards the inside of the bend, based on the steering angle and driving speed. The static cornering lights activate the auxiliary headlights so as to illuminate more of the road at tight bends and turns. In addition, beam distribution is continuously adapted to the driving speed and prevailing light conditions.

Another feature, the adverse weather function, is activated whenever the rear fog light is switched on. It improves safety by reducing the dazzle and providing better illumination of the kerbside.

Porsche Dynamic Light System Plus (PDLS+).

Porsche Dynamic Light System Plus (PDLS+) is available as an option for the Panamera Turbo – and available only in conjunction with LED main headlights for all other models. Not only does PDLS+ offer all the functions of PDLS, it also features a dynamic main beam and an intersection assistant function.

The dynamic main beam is activated from a speed of 65 km/h and detects vehicles driving in front as well as

oncoming traffic. The intensity and range of the light cone is therefore adapted to the prevailing situation.

With the intersection assistant function, intersections and T junctions are recognised based on the navigation data of PCM. For optimum illumination of intersections, the system automatically switches on the left and right cornering lights. At a T junction, only the static cornering light on the same side as the emerging traffic is switched on.

LED main headlights including Porsche Dynamic Light System Plus (PDLS+).

Available on request: LED main headlights including Porsche Dynamic Light System Plus (PDLS+). The inner workings of each headlight comprise two light units in a stepped arrangement. The daytime running lights, each with four LED spotlights forming a continuous ring of light, are integrated into the headlights – a design feature that reinforces the imposing appearance of the Panamera models.

The LED beam is remarkably powerful and provides excellent illumination of the road. Thanks to the optimum balance between short and long distance lighting with side illumination, the similarity in colour to daylight and low light scatter, the driver's eyes tire less quickly than with other systems.



Daytime running lights of the LED main headlights



Night light design of the LED main headlights

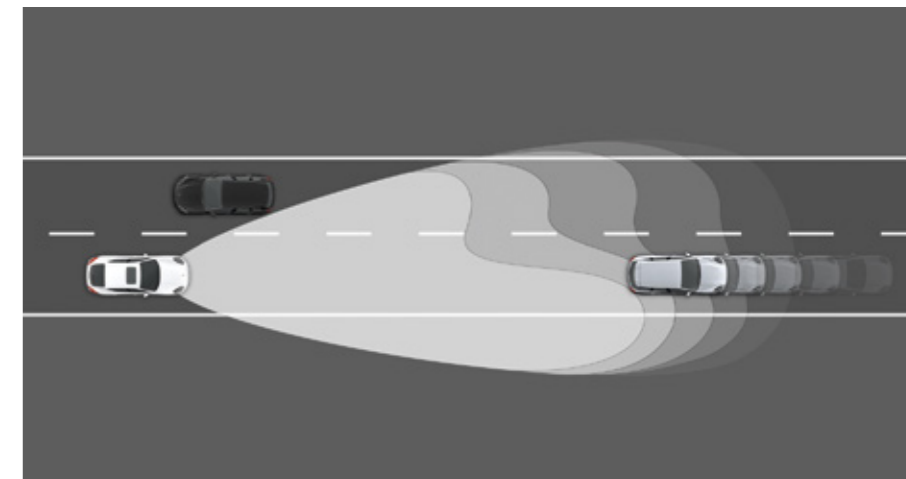

Porsche Dynamic Light System Plus (PDLS+)



LED main headlight



Panamera 4S with Porsche Ceramic Composite Brake (PCCB)

Sometimes, even short distances mean major progress.

Brakes.

The Panamera models have a braking system equipped with six-piston aluminium monobloc fixed brake calipers at the front and four-piston units at the rear. The brake calipers on the Panamera and Panamera 4 are finished in black; on the Panamera S models, they are silver-coloured; on the Panamera S E-Hybrid they are Acid Green, and on the Panamera GTS and Panamera Turbo they are red.

The brake discs are slotted and internally vented for enhanced braking performance – even under extreme conditions – and rapid heat dispersal. The brake discs on the Panamera Turbo and Panamera GTS have a diameter of 390 mm at the front

and 350 mm at the rear, whilst on the other Panamera models the discs are 360 mm in diameter at the front and 330 mm at the rear.

The electric parking brake, which you can activate and deactivate manually, releases automatically as you pull away. Thanks to the hold function, you can pull away without ever rolling back.

Porsche Ceramic Composite Brake (PCCB).

On request, your Panamera can be fitted with a braking system that has proven itself on the racetrack: the Porsche Ceramic Composite Brake (PCCB). The cross-drilled ceramic brake discs on the

Panamera Turbo and Panamera GTS have a diameter of 410 mm at the front and 350 mm at the rear.

The other models feature discs with a diameter of 390 and 350 mm at the front and rear, respectively.

PCCB is characterised by its low thermal expansion under heavy braking, which helps to prevent deformation. Furthermore, the ceramic brake discs are totally resistant to corrosion and offer better noise-damping properties.

The key advantage of PCCB is the extremely low weight of the brake discs, which are approximately 50% lighter

than standard discs of similar design and size. Although enhanced performance and fuel economy are very noticeable benefits: above all, it represents a major reduction in unsprung and rotating masses. That means better handling, better roadholding and increased comfort, particularly on uneven roads.

In addition to the regular servicing work performed within the standard service intervals, additional servicing should be performed if used on the racetrack.

Optional for the Panamera Turbo and Panamera GTS in conjunction with 20-inch wheels; for other Panamera models, only compatible with 19-inch wheels or larger.

Engineered body design.

The lightweight bodyshell construction, made from super-high-strength steels, stainless steel, magnesium and aluminium, ensures a low overall weight. It also produces a highly resilient passenger cell that offers high levels of protection in the event of an impact. The system of longitudinal and transverse members at the front absorbs deformation energy and disperses the forces, thereby minimising deformation of the interior. In addition, passive safety is further enhanced by the front axle aluminium subframe, which is designed to deform in a defined manner. A rigid bulkhead cross member reduces

deformation of the footwell in the event of an impact and provides improved protection for the feet and legs. In a minor collision, a system of easily replaceable impact absorbers prevents costly damage to the underlying bodyshell.

Active bonnet system.

The active bonnet system is designed with enhanced pedestrian safety in mind. The moment the sensors in the front apron detect a collision, this pyrotechnically assisted system raises the rear portion of the bonnet, which can help to reduce the risk of injury.

Airbags and seat belt system.

All Panamera models are fitted, as standard, with full-size driver and front passenger airbags. Depending on the severity and type of accident, they are inflated in two stages. In less serious accidents, the airbags are only partially inflated, thereby minimising discomfort to the occupants.

As well as knee airbags for driver and front passenger, the Porsche Side Impact Protection System (POSIP) is also fitted as standard.

This comprises side airbags in the front seats, curtain airbags along the entire roof frame and the side windows from the A-pillar to the C-pillar, and side impact protection elements in the doors. Side airbags in the rear compartment are available as an option. Also featured as standard are an energy-absorbing steering column, automatic three-point seat belts, belt height adjustment and seat belt pretensioners front and rear. A rollover sensor automatically activates the curtain airbags and seat belt pretensioners if the vehicle threatens to overturn.





Panamera with 19-inch Panamera Classic wheels, Panamera S E-Hybrid with 20-inch Panamera Sport wheels

**There is only one place we like to leave a lasting mark:
in a person's heart.**

Porsche and the environment.

Environmental protection.

Electromobility is the topic of the day. After all, we are all searching for answers to one of the greatest challenges of our time: how to conserve resources. How can we reduce energy requirements and CO₂ emissions? Our answer is e-mobility. In other words, sustainable mobility. Our solution is the Panamera S E-Hybrid. Here, we substitute oil with regenerative electricity and combine high performance with excellent everyday practicality.

With hybrid technology, we are exploring new directions without losing sight of familiar ground: Porsche has managed to

reduce fuel consumption across all current model ranges by a double-digit percentage compared with the previous generation. This is made possible by an efficient drive concept, lightweight construction, optimised aerodynamics and low rolling resistance.

Vehicles manufactured by Porsche prove that even high-performance sports cars can achieve comparatively moderate exhaust emission values in their respective category. This high degree of environmental responsibility is clearly demonstrated by our approach to environmental management at the Porsche Development Centre in

Weissach. Here, all technological developments are carried out with environmental protection in mind.

Lightweight construction and recycling.

Intelligent lightweight construction has been integral to the Porsche identity since the very beginning. For both economical and ecological reasons. This forms the basis for low fuel consumption values in conjunction with outstanding performance.

It is economical thanks to the high proportion of aluminium, plastics and super-high-strength sheet steel used. This is substantially more stable and lighter

than conventional steel. It is also ecological because all materials used are meticulously selected. We use only innovative and environmentally friendly components. All lightweight materials are easily recyclable and each material is labelled to facilitate its separation for recycling. The reduction in the number of plastic variants helps to ensure more efficient recycling. Recycled plastics are used where they meet our exacting technical requirements. As a result, the Panamera models are around 95% recoverable.



Style and feel. Personality.

Style lends self-assurance in our interaction with others and in tricky situations. Indeed, it is only when we remain distinguishable that style does not become outmoded through formality. It takes a certain feel. It takes one's own ideas and impulses. That's when style becomes our own personal style.

There's nothing quite like being surrounded by familiarity. Even when you're on the move.

Interior.

Your first impression of the Panamera interior is the generous amount of comfort. The second impression is one of sporty lightness and excellent ergonomics. The five round instruments have an integrated 4.8-inch colour screen. The centre console ascends towards the front, shortening the reach between the steering wheel and the gear selector. All the important controls are arranged into logical groups to give you quick access to important functions without the need to browse through long sub-menus.

Smooth-finish leather, natural leather, two-tone colour combinations, elegant woods, aluminium and carbon – thanks to these, and many more personalisation options, you can make your Panamera even more sporty or even more comfortable. Or both. In the Panamera Turbo and Panamera GTS, the roof lining is upholstered in Alcantara as standard (optional for all other models). For more detailed information about colours and personalisation, please refer to page 110 onwards.

The Panamera models offer a variety of storage options, for example in the doors and centre console. There is a cupholder in the front centre armrest and two cupholders in the rear compartment. On request – at no extra charge – it is possible to have a further two fold-out cupholders fitted above the glove compartment.

For extra storage space, a large centre console is available as an option for the rear compartment. It comes with a

230-volt socket, an additional 12-volt socket and preparation for a cooling compartment. The interior lighting concept with switch-off delay is practical and appealing. This includes illuminated door handles and storage compartments in the front, orientation lights, front footwell lights and also reading lights and interior lights – one of each for all four seats.



Panamera S E-Hybrid interior in Marsala, brushed aluminium interior package and other optional equipment



Interior lighting package for rear compartment

An optional interior lighting package conceived specifically for the rear adds two reading lights to the overhead console, lights in each footwell, additional orientation lighting in the rear, and illumination for door storage compartments and the compartment in the rear centre console. These are

predominantly powerful yet energy-efficient LEDs. The additional ambient lighting on the overhead consoles in the front and rear and the reading lights are dimmable.

Automatic climate control, with zonal regulation in the front compartment, is

integrated as standard. An active carbon filter traps particles, pollen and odours. Four-zone automatic climate control, with separate temperature controls for all four seats, is available as an option.

Thermally and noise-insulated glass can be fitted as an option, as can dark-tinted privacy glazing which will maintain your privacy and protect the interior from the effects of strong sunlight. Just like the electric roll-up sunblinds in the rear compartment and on the rear side windows.

Optional soft close doors are available for all Panamera models. A closing mechanism integrated in each door lock ensures comfortable and safe closing of all four doors.



Four-zone automatic climate control

Front seats.

The front seats with integrated headrests offer a high degree of comfort and hold your body firm during cornering, without restricting your freedom of movement. Seat adjustment is fully electric as standard, with controls on both the driver and front passenger sides for seat height, squab and backrest angle, and fore/aft position. A driver memory package, available as an option, enables the driver's seat and exterior mirror positions to be saved and restored automatically.

Optional comfort memory package (standard in the Panamera Turbo) for driver and front passenger offer even

more functionality. In addition to featuring an electric steering column adjustment facility, the package includes electric four-way lumbar support, electric seat squab length adjustment and personal memory settings for seat, steering wheel, PCM and mirror positions.

The courtesy lights (LEDs in the exterior mirrors) are a component of the driver memory package and comfort memory package. ISOFIX child seat mounting points are available as an option for the front passenger seat in conjunction with the deactivation function for the passenger airbag.

Adaptive Sports seats.

The optional adaptive Sports seats (standard in the Panamera GTS) have firmer – yet still comfortable – upholstery and provide even better lateral support thanks to the raised side bolsters on the seat squab and backrest.

Featuring 18-way electric adjustment, the seats can be optimally adapted to meet your needs in terms of seat height, squab and backrest angle, squab length, fore/aft adjustment and four-way lumbar support. The steering column is also electrically adjustable. In addition, the side bolsters on the seat squab and backrest are independently adjustable

for added comfort over long distances or precision lateral support on winding roads. Also included is the personal memory for the driver and front passenger seats (including lumbar support), the steering wheel and the driver's exterior mirror.



Standard front seat



Adaptive Sports seat (front)



Eight-way power seats (rear) (in conjunction with large centre console) with comfort headrests

Rear seats.

The rear compartment has two fully independent seats with plenty of leg- and headroom, even for taller passengers. They provide good lateral support, even during fast cornering, with no compromise on comfort. Between the seats is a folding armrest with a handy storage compartment. The backrests fold down individually with a ratio of 40:60 to increase storage capacity or to accommodate larger items. The split is 40:20:40 in conjunction with the optional ski bag. With the optional large centre console, the backrests can still be folded separately while the console itself remains fixed in position.

Eight-way power seats are available as an option for the rear in any of the Panamera models. In addition to the electric backrest adjustment, seat squab

length adjustment and lumbar support functions, there is a facility to adjust the front passenger seat from the rear. When specified in conjunction with seat ventilation, the eight-way power seats (rear) feature automatic comfort headrests (p. 90). In conjunction with the adaptive Sports seats in the front, Sports seats are also fitted in the rear and feature a sporty seam design and elevated side bolsters.

ISOFIX child seat mounting points are fitted as standard on both rear seats in all Panamera models.

Seat heating and ventilation.

The front seats of the Panamera S models, the Panamera GTS and the Panamera Turbo feature seat heating as standard (optional for the Panamera and Panamera 4). This heats the seat squab and backrest to a pleasant

temperature. In the Panamera Turbo, the seats in the rear also have a heating function (optional for all other models).

On request, we can equip the front seats, indeed all four seats, with seat ventilation (only in conjunction with seat heating). A slipstream effect is produced by active ventilation of the perforated seat centre and backrest and by passive aeration at the side bolsters. This evaporates perspiration moisture and therefore makes for a comfortable seating environment, even in hot weather. Seat heating and seat ventilation can be adjusted independently to any one of three power levels.



Rear seats

**You can set your sights on any destination of choice.
Will you take the direct route, the fast route or the scenic route?**

Audio and communication options.

CDR audio system.

The CDR audio system has a 7-inch colour touchscreen so that you can navigate and select the most important functions and menus with ease and efficiency. The integrated CD radio, with FM twin tuner and RDS diversity, 30 memory presets, dynamic autostore and speed-sensitive volume control, includes a sound system with 10 loudspeakers and a total audio output of 100 watts. An optional integrated CD autochanger holds up to six CDs.

Standard in the Panamera models (except Panamera Turbo).

CDR Plus audio system.

Optional CDR Plus has 11 loudspeakers and delivers a total output of 235 watts. Functions are controlled using a high-resolution colour touchscreen. On request, it is possible for CDR Plus to be combined with the Burmester® (p. 98) and BOSE® (p. 98) sound systems. An analogue and digital twin tuner ensures an extensive selection of radio broadcasts. Other features include a DVD audio drive supporting audio playback of MP3 files and audio/video DVDs, and a USB port for various iPod® and iPhone® models, MP3 players and USB memory sticks containing MP3 tracks. Album cover art is also supported. Connected USB devices can be controlled via CDR

Plus or the multifunction steering wheel. An AUX interface enables you to connect additional external audio sources, in which case functions are controlled directly from the external device.

Porsche Communication Management (PCM) including navigation module.

Porsche Communication Management (PCM) is your control centre for audio, navigation and communication functions. It is powerful and multifunctional, yet intuitive to use. The most important component is the 7-inch high-resolution touchscreen with graphical user interface. Alternatively, you can operate PCM using separate rotary pushbutton controls. The radio has an FM twin tuner,

while the DVD audio drive plays CDs and audio DVDs and is MP3-compatible. A six-disc CD/DVD autochanger integrated in PCM is available as an option. The optional universal audio interface (USB) allows you to store and play up to 5,000 MP3 files on the 40-GB internal hard drive.

In conjunction with PCM, a total output of 235 watts is produced through a combination of 11 loudspeakers. In the Panamera Turbo, the BOSE® Surround Sound System (p. 98) is fitted as standard and features 14 loudspeakers delivering a total output of 585 watts. For an even greater sound experience, PCM can be combined

with the optional Burmester® High-End Surround Sound System to offer over 1,000 watts produced by 16 direct-drive loudspeakers (p. 98, not for the Panamera S E-Hybrid).

The TV tuner, available as an option for PCM, receives free-to-air analogue and digital television broadcasts.

A navigation module with high-speed hard drive is included with PCM. For route guidance, it is possible to select between a 2D display and a 3D perspective. In some regions, even buildings can be shown in 3D, as can the terrain, the latter superimposed with a satellite map image. Split-screen mode enables you to view two functions at once, such as the current navigation map and list of symbols that represent your next driving instructions. The navigation module also features dynamic route guidance, which recalculates the route in response to

official traffic messages (TMC) and information from traffic flow sensors (TMC Pro).

One key function of PCM in the Panamera S E-Hybrid is the graphical display of the hybrid drive system showing the flow of energy in the various modes, such as all-electric mode, e-boost, recuperation or coasting. Another display – ‘Hybrid Zero Emission’ – shows you the amount of time, as a proportion of the total driving time, that you have spent driving without the combustion engine.

Standard in the Panamera Turbo, optional for the other Panamera models.



CDR audio system



Porsche Communication Management (PCM)



Porsche Rear Seat Entertainment Plus

Digital radio.

This option enables reception of digital radio broadcasts in the DAB, DAB+ and DMB audio formats, offering far superior sound quality.¹⁾ Automatic changeover between digital and analogue ensures optimum reception of the selected station.

Universal audio interface.

Enhance your CDR audio system or PCM with an optional connectivity package: for the CDR audio system, an AUX port (e.g. to connect a compatible MP3 player); for PCM, an AUX interface and a

USB port for connecting your iPod® or iPhone®.²⁾ Your iPod®, iPhone®, compatible MP3 player or a USB stick connected to the USB interface can be controlled using PCM. Through the USB port, it is possible to transfer up to 5,000 tracks in MP3 format to the 40-GB internal hard drive of PCM, where they can be accessed for direct playback. Playback of recognised podcast and audiobook formats is supported and cover art is displayed. Contact your Porsche Centre for further information.

Porsche Rear Seat Entertainment Plus.³⁾

Big cinema in the second row: the new Porsche Rear Seat Entertainment Plus has been developed especially to meet the high demands of a Porsche. With two separate 10.1-inch touchscreens mounted on the front seat backrests, integrated DVD drive, SD card slot, 32-GB internal flash memory and optimal WLAN router there's a lot of entertainment to be had – surfing the web, for example, with the system's own Internet browser. While the wireless Bluetooth® headphones provide the perfect sound experience.

Voice control system.

Do you require navigation assistance, need to make a phone call or simply want to listen to the radio? Then why not just say so? The voice control system for PCM is at your command with support for word-by-word input. Voice control allows the cohesive input of destination addresses, phonebook entries or radio station names. You can also scroll through lists by voice control.

¹⁾ Reception is dependent on local network availability.

²⁾ For information on compatibility with iPod® models, please contact your Porsche Centre.

³⁾ Available from 06/2015 at the earliest.



Telephone module



Online services

Electronic logbook.

An electronic logbook is available for PCM as an option. It automatically logs the mileage, route distance, date, time, starting location and destination for every journey. The software fulfils all statutory requirements for automatic logbooks as specified by the German revenue authorities.

Telephone module.

The quadband GSM telephone module is available as an option for PCM and offers convenience and excellent reception. With a SIM card inserted directly into PCM's integral SIM card reader, calls can be made using either the hands-free facility or the cordless handset. Alternatively, the Bluetooth® capability of a mobile phone can be used to make calls through the SIM Access Profile (SAP). Once automatic pairing is complete, the mobile phone's aerial is switched off to conserve battery charge and the phone operates via the car aerial.

Depending on the type of mobile phone, this gives access not only to the numbers on the SIM card, but also to the phone's internal memory. Also, depending on the phone, it can be controlled using PCM, the multifunction steering wheel or the voice control system without it ever leaving your pocket. In addition, the telephone module enables you to establish a Bluetooth® link with those mobile phones that only support the Handsfree Profile (HFP). In this case, the GSM connection is always established through the aerial of the

mobile phone. PCM acts as a hands-free system and you can leave the mobile phone tucked away. Please refer to the note on page 136.

To make a private call, despite having other passengers in the vehicle, the telephone module includes a Bluetooth® handset with display and keyboard located in the centre console. However, the handset cannot be used for Bluetooth® links established using the Handsfree Profile (HFP).

Mobile phone preparation.

An optional mobile phone preparation is available to enable a Bluetooth® connection for those mobile phones that only support the Handsfree Profile (HFP). This function also enables you to leave your mobile phone tucked away. The CDR audio system and PCM can be used to control only the basic functions of the mobile phone and the GSM connection is established through the mobile phone's aerial. Please refer to the note on page 136.

Online services.

With the free-to-download Aha Radio app, you can use your smartphone to stream Internet radio, news feeds, podcasts and audiobooks directly to the PCM. Local information, such as hotel and restaurant listings, can be read aloud automatically thanks to the text-to-speech functionality. Point of Interest searches with subsequent direct selection as your navigation destination are also supported. The online content is received by your smartphone and controlled via the PCM.

**You like a pounding drum beat.
But still appreciate a little nuance.**

Sound systems.

BOSE® Surround Sound System.

The BOSE® Surround Sound System is compatible with Porsche Communication Management (PCM) as well as the CDR and CDR Plus audio systems. The system comprises nine amplifier channels. Its 14 loudspeakers and 200-watt active subwoofer deliver a balanced acoustic pattern and transform your Panamera into a concert hall. Total output: 585 watts (Panamera S E-Hybrid: 160-watt active subwoofer, 545-watt total output).

In combination with PCM, the BOSE® Surround Sound System enables audio playback of DVDs. Of course, you can

still play other audio sources such as CDs and MP3s. In stereo, or at the push of a button, in one of the virtual surround modes generated by BOSE® Centerpoint® 2. The patented AudioPilot® Noise Compensation Technology uses a microphone to continuously measure all the noises inside the vehicle and adapts music playback automatically so that a consistent sound is maintained – whatever the driving conditions and in real time.

The result is a balanced, faithfully reproduced sound and a captivating 360° acoustic experience delivered to all four seat positions.

Burmester® High-End Surround Sound System.

The sound developed by our research centre in Weissach is amplified by a sound from Berlin. We're referring to Burmester®, one of the most respected manufacturers of high-end audio equipment worldwide, and the Burmester® High-End Surround Sound System, which is available as an option in combination with the CDR audio system or PCM. The technologies behind the system are from the finest of the premium home audio systems that Burmester® has to offer, and it owes its eminence to countless details, and one goal: perfection in sound.

The system has 16 amplifier channels with a total output of more than 1,000 watts, 16 loudspeakers including an active subwoofer with 300-watt class D amplifier, a total diaphragm surface area of more than 2,400 cm², and a frequency response of 30 Hz to 20 kHz. Crossover technology has been carried over more or less unmodified from the home audio sector. Analogue and digital filters have been optimally defined for their installation location and finely tuned after extensive in-car audio testing. Ribbon tweeters have been used for unmistakably fine, clear and undistorted high-frequency sound reproduction with excellent level stability. All loudspeaker

housings are perfectly matched and deliver superior bass foundation, definition and impulse accuracy. As yet unequalled, the result is a natural and richly textured spatial sound, even at top volume. The elegantly pure design with galvanised surrounds and Burmester® logos on selected loudspeakers make it clear that the appeal of the Burmester® High-End Surround Sound System is as much about the visual as it is the audio. Sound and style without compromise.

Optional for all Panamera models except the Panamera S E-Hybrid.



Hindsight, insight, foresight.
Even your Panamera knows that three pairs of eyes see better than one.

Assistance systems.

Porsche Car Connect.

Short, direct routes – this has been a Porsche principle since the very beginning. And it's the same in the digital age. Porsche Car Connect is the gateway between your Panamera and the possibilities of the 21st century and it strengthens the bond between your Panamera and you. After all, the relationship between a sports car and its driver ought to be a close one.

Porsche Car Connect is a smartphone app that enables you to access various data relating to your car and control certain functions remotely.

Carfinder displays the shortest route from your current position to your car's parked location.

Thanks to Remote Vehicle Status, the most important data from your Panamera are always available at a glance. For example, you can call up your odometer reading and fuel level or check whether the windows and doors are open or closed.

Remote Services gives you fingertip access to a range of statistics recorded by your car, including distance covered, average speed and fuel consumed during the last drive.

A particularly practical function of Porsche Car Connect is the ability to make a breakdown call from any location. You can also check the status of the alarm system whenever you want to and wherever you are. In addition, you can use your smartphone to control the locking of doors and the folding of the exterior mirrors.

Porsche Car Connect also includes the Porsche Vehicle Tracking System (PVTs), which enables the remote location of a stolen vehicle across most of Europe.

For the Panamera S E-Hybrid, Porsche Car Connect is enhanced with a comprehensive range of E-Mobility Services tailored specifically to this vehicle concept. Features include an overview of the current battery charge state and available all-electric range. You can also control the air conditioning of your car remotely as desired. You will find further information about E-Mobility Services on page 34.

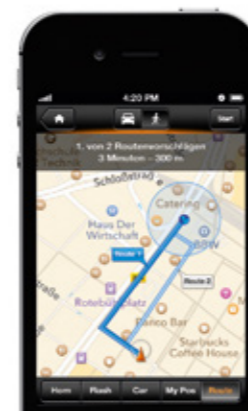

ParkAssist.

ParkAssist is standard in all Panamera models. With six sensors at the front and four sensors at the rear, the system audibly alerts the driver to the presence of obstacles detected behind the vehicle. An intermittent warning tone increases in rapidity as the obstacle is approached.

The audible alert is supplemented by a visual warning in the central display screen which provides a graphical representation of the vehicle's proximity to obstacles.

Reversing camera.

The optional reversing camera facilitates precise reverse parking and manoeuvring and also assists in hitching a trailer. Help is provided in the form of the camera image and the dynamic, superimposed guidelines on the PCM screen, which illustrate the predicted course of the vehicle given the current position of the steering wheel.

Surround View.

The optionally available Surround View system supplements the reversing camera with three more high-resolution cameras – one in the front apron and one in each lower trim of the exterior mirrors. Based on the information supplied by all four cameras, the system generates

a virtual bird's eye view of the car and displays it on the PCM screen. This provides additional assistance to the driver when parking and manoeuvring because even low-level obstacles to the front and side of the vehicle can be detected. It is also possible to switch between various camera views to improve visibility, e.g. at narrow exits.

Cruise control.

Cruise control is fitted as standard for added driver comfort on long stretches of road. Cruise control operates in the 30 to 240 km/h speed range and is selected using a button on the steering column control stalk.

Adaptive cruise control including Porsche Active Safe (PAS).

Available as an option, this enhanced version of cruise control regulates the speed of your vehicle in line with the speed of the vehicle in front. A radar sensor inside in the front end scans the road ahead up to a distance of 200 m. Imagine you've selected a cruising speed but have begun to gain on the vehicle in front because it is driving more slowly – the system reduces the speed of your vehicle by restricting throttle or gently applying the brakes until your chosen distance from the vehicle in front is maintained. For safety reasons, the driver should always be prepared to intervene manually if heavier braking is required.

If the vehicle ahead slows further, adaptive cruise control will decelerate your Panamera accordingly – even down to a halt. As soon as the road ahead clears, your vehicle will accelerate back up to the cruising speed originally set. Selectable cruising speeds range from 30 to 210 km/h. To pull away after an automatic stop, simply press the control lever or depress the accelerator pedal. If desired, the driver can enable the integrated stop-and-go function, which automates stopping and pulling away in congested traffic.

Safety is further improved by Porsche Active Safe (PAS). If you are approaching the vehicle in front too quickly, you will be prompted to take the necessary action by an audible and visual warning as well as a jolt of the brakes. The system may also intervene with targeted braking applications and act to boost brake pressure as the situation demands, even to the point of the maximum braking force that the system is able to provide.



Graphical display of the ParkAssist (front and rear)



Reversing camera



Speed limit indicator

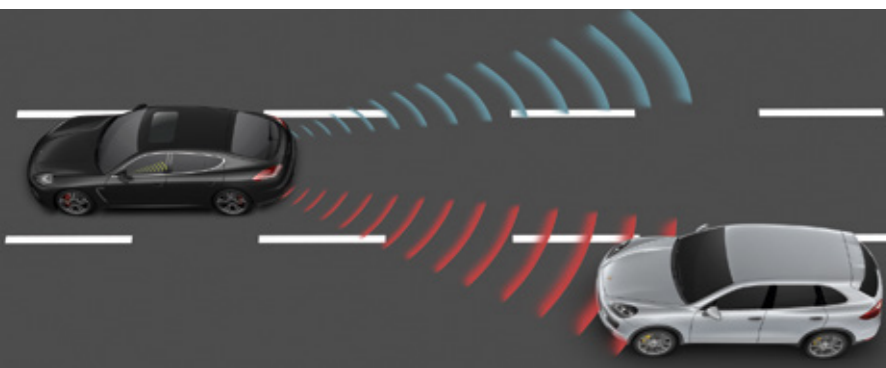

Lane Change Assist



Adaptive cruise control with Lane Departure Warning

Lane Change Assist.

The optional Lane Change Assist uses radar sensors to monitor the areas to the rear of your vehicle and the blind spots on either side. Above a speed of 30 km/h, the system issues a visual warning signal in the exterior mirrors whenever a vehicle rapidly approaches your vehicle from behind or enters one of your blind spots. This improves comfort and safety, particularly on motorways. However, LCA does not actively intervene to control the vehicle and can be deactivated at any time.

Lane Departure Warning.

A camera inside the rear-view mirror casing monitors the road surface in front of the vehicle. When activated, the system will sound a warning tone whenever you steer towards a divider line marking and threaten to leave the current lane without indicating.

Speed limit indicator.

The speed limit indicator (only in conjunction with PCM) is available for all models. A camera inside the rear-view mirror casing identifies traffic signs such as speed limits and 'no overtaking' zones (start and end). The speed limit or overtaking restriction is displayed to the driver via the instrument cluster and PCM. The advantage over information stored in the navigation database is that even temporary speed restrictions can be detected.

Porsche Entry & Drive.

Standard in the Panamera Turbo and optional for the other models: Porsche Entry & Drive – recognisable by the chrome surfaces on the door handles. Who needs a car key? As soon as you touch the door handle, Porsche Entry & Drive checks the encrypted access code on the key in your pocket. Once the key is validated, the door unlocks. The vehicle can then be started or switched off using the electronic ignition switch. To lock the vehicle, you simply press a button on the outside of the door handle. Porsche Entry & Drive then locks the vehicle and activates the engine immobiliser and steering column lock.

Anti-theft protection.

All Panamera models are protected by an immobiliser and an alarm system including ultrasonic interior surveillance. The system secures all four doors, the bonnet, the rear hatch, the passenger compartment, the ignition, the steering column and any trailer that may be attached.





Panamera with 19-inch Panamera Classic wheels

Your life has always made room for travel.

Luggage compartment.

The Panamera models offer 445 litres of luggage space (except the Panamera S E-Hybrid and Panamera Turbo). The Panamera S E-Hybrid provides you with 335 litres of luggage compartment capacity, and the Panamera Turbo 432 litres. All models offer enough room for four suitcases from the Porsche Driver's Selection range – colour coordinated with the exterior colour of your Panamera if you wish.

The automatic rear hatch with customisable opening angle is fitted as standard to all models. It closes conveniently at the push of a button.

By no means a common feature in this vehicle class is the fully or split-folding rear seats. The cargo position offers 1,263 litres of space (except in the Panamera S E-Hybrid and Panamera Turbo). In conjunction with the BOSE® Surround Sound System or Burmester® High-End

Surround Sound System, there are 1,250 litres – including the Panamera Turbo – and 1,153 litres in the Panamera S E-Hybrid. A ski bag is available as an option and, to accommodate it, the centre section between the rear seats folds separately. To protect from prying eyes, the luggage compartment can be covered with the removable roller cover which is provided as standard.

The fixed luggage compartment cover is available as an option. For extra protection for the luggage compartment, this cannot be removed until the rear hatch is opened. A roll-up sunblind offered as an option is compatible with either luggage cover. Controlled electrically, it can be raised behind the rear seats for extra privacy.



Expression and strengths. Individuality.

Colours, materials and features. All the hallmarks of individuality. At least they are when they aren't allowed to succumb to fashion. We don't mirror the latest trends – we reflect our own image. Only then does our appearance give expression to our inner strengths.



Colours.

The extensive colour range of the Panamera models offers no fewer than 16 exterior colours, seven interior colours and seven two-tone combinations, plus eight interior packages in aluminium, carbon or a selection of woods. If you can't find the colour you'd like for your Panamera model, we can probably mix it for you. For more information, see the Porsche Exclusive Panamera catalogue. Using the Porsche Car Configurator at www.porsche.com, you can see how the available colours would look on your virtual car, not only on the exterior, but in the interior, too.

Solid exterior colours.

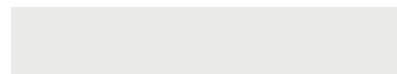

White



Black



Metallic exterior colours.

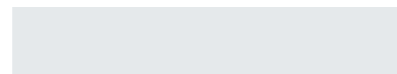

Carrara White Metallic



Rhodium Silver Metallic



Sapphire Blue Metallic



Ruby Red Metallic



Chestnut Brown Metallic



Mahogany Metallic



Night Blue Metallic



Carbon Grey Metallic



Agate Grey Metallic



Jet Black Metallic



Special exterior colours.



GT Silver Metallic



Palladium Metallic



Carmine Red



Amethyst Metallic



Standard interior colours.

Leatherette/leather/soft-touch paint.

Interior colour. **Carpet.** **Roof lining.**

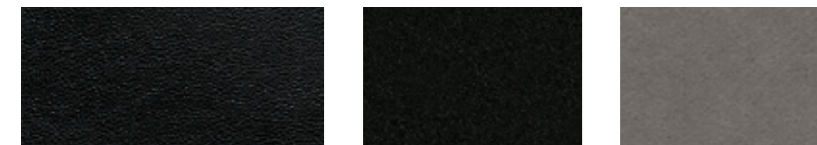

Black Black Platinum Grey²⁾



Agate Grey Agate Grey Platinum Grey

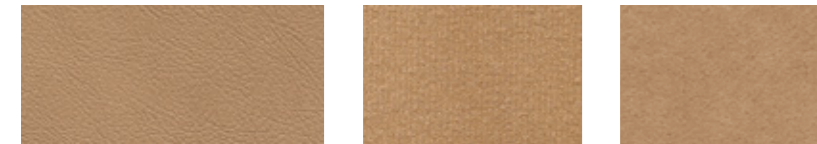

Luxor Beige Luxor Beige Luxor Beige

Partial leather package in two-tone combination.¹⁾

Leatherette/leather/soft-touch paint.

Interior colour. **Carpet.** **Roof lining.**

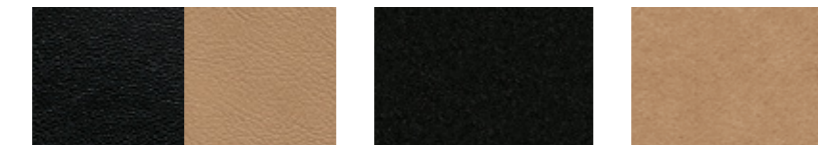

Black and Luxor Beige Black³⁾ Luxor Beige

Leather interior package in standard colours.

Leather/soft-touch paint.

Interior colour. **Carpet.** **Roof lining.**

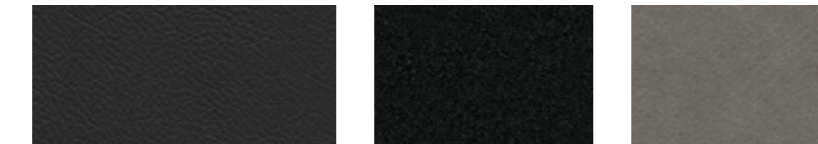

Black Black Platinum Grey²⁾

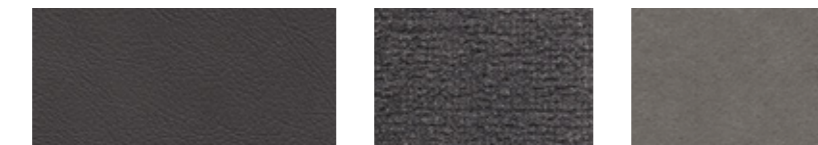

Agate Grey Agate Grey Platinum Grey

Leather/soft-touch paint.

Interior colour. **Carpet.** **Roof lining.**



Luxor Beige Luxor Beige Luxor Beige



Marsala Marsala Platinum Grey



Saddle Brown Saddle Brown Saddle Brown

Leather package in two-tone combination.

Leather/soft-touch paint.

Interior colour. **Carpet.** **Roof lining.**



Luxor Beige and Cream Cream³⁾ Cream



Marsala and Cream Cream³⁾ Cream

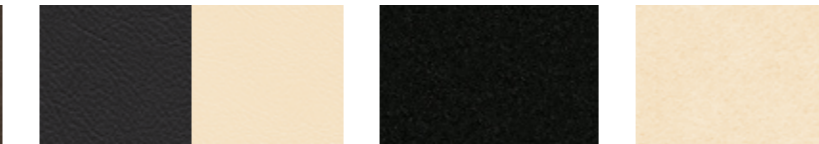

Black and Cream Black³⁾ Cream

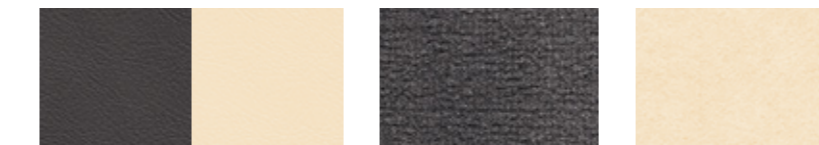

Agate Grey and Cream Agate Grey³⁾ Cream

Leather/soft-touch paint.

Interior colour. **Carpet.** **Roof lining.**



Black and Garnet Red Black³⁾ Black

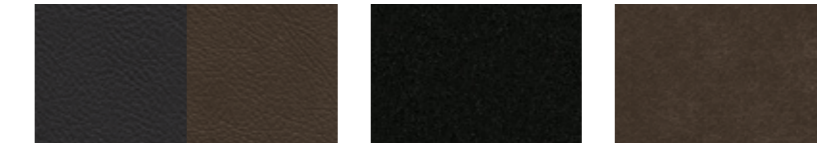

Black and Saddle Brown Black³⁾ Saddle Brown

Leather package in natural leather.

Leather/soft-touch paint.

Interior colour. **Carpet.** **Roof lining.**

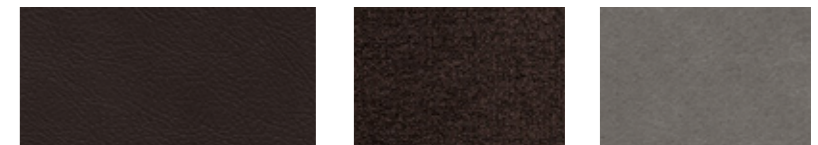

Espresso espresso Platinum Grey



Cognac Cognac Cedar

¹⁾ Extra-cost option.
²⁾ In conjunction with roof lining in Alcantara (standard in the Panamera GTS and Panamera Turbo models) black.
³⁾ With two-tone packages, the luggage compartment is styled in the respective darker colour.



Interior in Cognac natural leather, Yachting Mahogany interior package

Interior packages.



Dark walnut



Carbon



Brushed aluminium

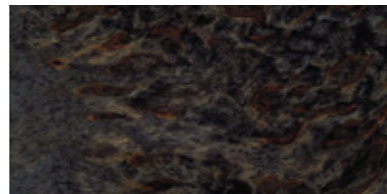

Anthracite birch



Tineo

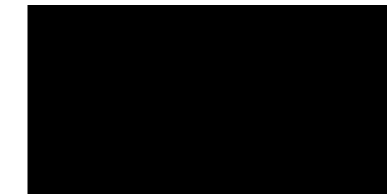

Black (high-gloss)

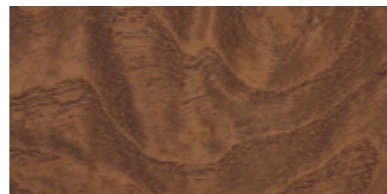

Natural olive



Yachting Mahogany

Options.

The comprehensive specification of the Panamera model range may be second to none, but at Porsche we appreciate that you may wish to tailor your Panamera entirely to your personal preferences. After all, every Porsche should have its own unique character.

There is a variety of individual items and equipment packages for the exterior and interior to choose from. You will find more detailed information on the following pages, on the Internet at www.porsche.com and in the separate price list.

These are just some of the many ways to style your Panamera to your personal preferences. How about having your car personalised at the factory through Porsche Exclusive or why not consider our range of aftermarket accessories from Porsche Tequipment? You will find plenty of inspiring ideas in all the relevant catalogues and your Porsche Centre will be happy to advise you.



Option	Panamera	Panamera 4	Panamera S	Panamera 4S	Panamera S E-Hybrid	Panamera GTS	Panamera Turbo	I no.	Page
Exterior.									
Metallic paint	<input type="checkbox"/>	<input type="checkbox"/>	<input type="checkbox"/>	<input type="checkbox"/>	<input type="checkbox"/>	<input type="checkbox"/>	<input checked="" type="checkbox"/>	Code	114
Special colours	<input type="checkbox"/>	<input type="checkbox"/>	<input type="checkbox"/>	<input type="checkbox"/>	<input type="checkbox"/>	<input type="checkbox"/>	<input type="checkbox"/>	Code	115
Colours to sample	<input type="checkbox"/>	<input type="checkbox"/>	<input type="checkbox"/>	<input type="checkbox"/>	<input type="checkbox"/>	<input type="checkbox"/>	<input type="checkbox"/>		
Sideskirts painted	-	-	-	-	-	<input type="checkbox"/>	-	569	
Bi-Xenon main headlights including Porsche Dynamic Light System (PDLS)	<input type="checkbox"/>	<input type="checkbox"/>	<input type="checkbox"/>	<input type="checkbox"/>	<input type="checkbox"/>	<input checked="" type="checkbox"/>	-	603	73
Porsche Dynamic Light System Plus (PDLS+)	-	-	-	-	-	-	<input type="checkbox"/>	632	74
LED main headlights including Porsche Dynamic Light System Plus (PDLS+)	<input type="checkbox"/>	<input type="checkbox"/>	<input type="checkbox"/>	<input type="checkbox"/>	<input type="checkbox"/>	<input type="checkbox"/>	-	602	74, 123
Porsche Entry & Drive	<input type="checkbox"/>	<input type="checkbox"/>	<input type="checkbox"/>	<input type="checkbox"/>	<input type="checkbox"/>	<input type="checkbox"/>	<input checked="" type="checkbox"/>	625	106, 123
Automatically dimming mirrors	<input type="checkbox"/>	<input type="checkbox"/>	<input checked="" type="checkbox"/>	<input checked="" type="checkbox"/>	<input checked="" type="checkbox"/>	<input checked="" type="checkbox"/>	<input checked="" type="checkbox"/>	260/261	
ParkAssist (front and rear) including reversing camera	<input type="checkbox"/>	<input type="checkbox"/>	<input type="checkbox"/>	<input type="checkbox"/>	<input type="checkbox"/>	<input type="checkbox"/>	<input type="checkbox"/>	638	102
ParkAssist (front and rear) including reversing camera and Surround View	<input type="checkbox"/>	<input type="checkbox"/>	<input type="checkbox"/>	<input type="checkbox"/>	<input type="checkbox"/>	<input type="checkbox"/>	<input type="checkbox"/>	633	102

* For Panamera GTS, black finish on the inside.

The vehicles illustrated in the chapter on personalisation may include additional options not featured in this catalogue. For information on these options, please consult your Porsche Centre. For detailed information on specific optional equipment and packages, please refer to the separate price list.

- not available I number/extra-cost option standard equipment available at no extra cost



Front camera – Surround View



LED main headlight including Porsche Dynamic Light System Plus (PDLS+)



Porsche Entry & Drive



Privacy glazing



Electric slide/tilt glass sunroof



Roof transport system

Option**Exterior.**

	Panamera	Panamera 4	Panamera S	Panamera 4S	Panamera S E-Hybrid	Panamera GTS	Panamera Turbo	I no.	Page
Privacy glazing	<input type="checkbox"/>	<input type="checkbox"/>	<input type="checkbox"/>	<input type="checkbox"/>	<input type="checkbox"/>	<input type="checkbox"/>	<input type="checkbox"/>	866	87, 124
Thermally and noise insulated glass	<input type="checkbox"/>	<input type="checkbox"/>	<input type="checkbox"/>	<input type="checkbox"/>	<input type="checkbox"/>	<input type="checkbox"/>	<input type="checkbox"/>	865	87
Thermally and noise insulated glass including privacy glazing	<input type="checkbox"/>	<input type="checkbox"/>	<input type="checkbox"/>	<input type="checkbox"/>	<input type="checkbox"/>	<input type="checkbox"/>	<input type="checkbox"/>	864	87, 124
Electric slide/tilt glass sunroof	<input type="checkbox"/>	<input type="checkbox"/>	<input type="checkbox"/>	<input type="checkbox"/>	<input type="checkbox"/>	<input type="checkbox"/>	<input type="checkbox"/>	650	124
Deletion of 'GTS' logo on doors	-	-	-	-	-	<input type="checkbox"/>	-	712	
Roof transport system	<input type="checkbox"/>	<input type="checkbox"/>	<input type="checkbox"/>	<input type="checkbox"/>	<input type="checkbox"/>	<input type="checkbox"/>	<input type="checkbox"/>	549	125
Rear wiper	<input type="checkbox"/>	<input type="checkbox"/>	<input type="checkbox"/>	<input type="checkbox"/>	<input checked="" type="checkbox"/>	<input type="checkbox"/>	<input type="checkbox"/>	425	
Preparation for towbar system	<input type="checkbox"/>	<input type="checkbox"/>	<input type="checkbox"/>	<input type="checkbox"/>	-	<input type="checkbox"/>	<input type="checkbox"/>	216	
Electrically extending towbar system	<input type="checkbox"/>	<input type="checkbox"/>	<input type="checkbox"/>	<input type="checkbox"/>	-	<input type="checkbox"/>	<input type="checkbox"/>	206	
Deletion of model designation	<input type="checkbox"/>	<input type="checkbox"/>	<input type="checkbox"/>	<input type="checkbox"/>	<input type="checkbox"/>	<input type="checkbox"/>	<input type="checkbox"/>	498	
Exterior package in black (high-gloss)	<input type="checkbox"/>	<input type="checkbox"/>	<input type="checkbox"/>	<input type="checkbox"/>	<input type="checkbox"/>	<input checked="" type="checkbox"/>	<input type="checkbox"/>	806	121

The vehicles illustrated in the chapter on personalisation may include additional options not featured in this catalogue. For information on these options, please consult your Porsche Centre. For detailed information on specific optional equipment and packages, please refer to the separate price list.

- not available I number/extra-cost option standard equipment available at no extra cost

Option	Panamera	Panamera 4	Panamera S	Panamera 4S	Panamera S E-Hybrid	Panamera GTS	Panamera Turbo	I no.	Page
Engine, transmission and chassis.									
Porsche Active Suspension Management (PASM)	<input type="checkbox"/>	<input type="checkbox"/>	<input checked="" type="checkbox"/>	<input checked="" type="checkbox"/>	<input type="checkbox"/>	<input type="checkbox"/>	<input type="checkbox"/>	475	65, 68
Adaptive air suspension including PASM	<input type="checkbox"/>	<input type="checkbox"/>	<input type="checkbox"/>	<input type="checkbox"/>	<input checked="" type="checkbox"/>	<input checked="" type="checkbox"/>	<input checked="" type="checkbox"/>	350/351	65
Porsche Dynamic Chassis Control (PDCC) including Porsche Torque Vectoring Plus (PTV Plus)	<input type="checkbox"/>	<input type="checkbox"/>	<input type="checkbox"/>	<input type="checkbox"/>	<input type="checkbox"/>	<input type="checkbox"/>	<input type="checkbox"/>	715	67
Power steering Plus	<input type="checkbox"/>	<input type="checkbox"/>	<input type="checkbox"/>	<input type="checkbox"/>	<input checked="" type="checkbox"/>	<input type="checkbox"/>	<input type="checkbox"/>	658	62
Sport Chrono Package	<input type="checkbox"/>	<input type="checkbox"/>	<input type="checkbox"/>	<input type="checkbox"/>	<input type="checkbox"/>	<input checked="" type="checkbox"/>	<input type="checkbox"/>	640	68, 126
Porsche Ceramic Composite Brake (PCCB)	<input type="checkbox"/>	<input type="checkbox"/>	<input type="checkbox"/>	<input type="checkbox"/>	<input type="checkbox"/>	<input type="checkbox"/>	<input type="checkbox"/>	450	76, 126
Sports exhaust system	<input type="checkbox"/>	<input type="checkbox"/>	<input type="checkbox"/>	<input type="checkbox"/>	<input type="checkbox"/>	<input checked="" type="checkbox"/>	<input type="checkbox"/>	176/XLF	43, 56, 57, 127
100-litre fuel tank	<input type="checkbox"/>	<input type="checkbox"/>	<input type="checkbox"/>	<input checked="" type="checkbox"/>	<input type="checkbox"/>	<input checked="" type="checkbox"/>	<input checked="" type="checkbox"/>	081	
E-mobility.									
7.2-kW on-board charger	<input type="checkbox"/>	<input type="checkbox"/>	<input type="checkbox"/>	<input type="checkbox"/>	<input type="checkbox"/>	<input type="checkbox"/>	<input type="checkbox"/>	KB2	
Porsche Charging Dock for Porsche Universal Charger (AC)	<input type="checkbox"/>	<input type="checkbox"/>	<input type="checkbox"/>	<input type="checkbox"/>	<input type="checkbox"/>	<input type="checkbox"/>	<input type="checkbox"/>	NJ1	

The vehicles illustrated in the chapter on personalisation may include additional options not featured in this catalogue. For information on these options, please consult your Porsche Centre. For detailed information on specific optional equipment and packages, please refer to the separate price list.

– not available I number/extra-cost option standard equipment available at no extra cost



Porsche Ceramic Composite Brake (PCCB)



Sports exhaust system



Sport Chrono Package



Rapid cornering without PDCC (illustrative example)



Rapid cornering with PDCC (illustrative example)



18-inch Panamera wheel



18-inch Panamera S wheel



19-inch Panamera Turbo wheel



19-inch Panamera Turbo II wheel



19-inch Panamera Design II wheel



19-inch Panamera Classic wheel



20-inch RS Spyder Design wheel



20-inch Panamera Sport wheel



20-inch Panamera Sport wheel painted in black (high-gloss)



20-inch 911 Turbo II wheel



20-inch 911 Turbo Design wheel

The vehicles illustrated in the chapter on personalisation may include additional options not featured in this catalogue. For information on these options, please consult your Porsche Centre. For detailed information on specific optional equipment and packages, please refer to the separate price list.

– not available ○ 1 number/extra-cost option ● standard equipment □ available at no extra cost

Option

Wheels.

	Panamera	Panamera 4	Panamera S	Panamera 4S	Panamera S E-Hybrid	Panamera GTS	Panamera Turbo	I no.	Page
18-inch Panamera wheels	●	●	□	□	□	–	–	410	19, 128
18-inch Panamera S wheels	○	○	●	●	●	–	–	413	28, 128
19-inch Panamera Turbo wheels	○	○	○	○	○	□	□	415	128
19-inch Panamera Turbo II wheels	○	○	○	○	○	●	●	471	48, 128
19-inch Panamera Design II wheels	○	○	○	○	○	○	○	472	129
19-inch Panamera Classic wheels	○	○	○	○	○	○	○	436	108, 128
20-inch RS Spyder Design wheels	○	○	○	○	○	○	○	417	39, 128
20-inch Panamera Sport wheels	○	○	○	○	○	○	○	XRW	9, 128
Exclusive									
20-inch Panamera Sport wheels painted	○	○	○	○	○	○	○	XRX	
Exclusive									
20-inch Panamera Sport wheels painted in black (high-gloss)	○	○	○	○	○	○	○	XRY	128
Exclusive									
20-inch 911 Turbo II wheels	○	○	○	○	○	○	○	418	45, 129
20-inch 911 Turbo Design wheels	○	○	○	○	○	○	○	429	129
All-season tyres for 19-inch alloy wheels	○	○	○	○	○	○	○	235	
All-season tyres for 20-inch alloy wheels	○	○	○	○	○	○	○	234	
Wheel centres	○	○	○	○	○	●	○	446	
Wheel spacers, 5 mm	○	○	○	○	○	●	○	856	

Option	Panamera	Panamera 4	Panamera S	Panamera 4S	Panamera S E-Hybrid	Panamera GTS	Panamera Turbo	I no.	Page
Interior.									
Adaptive cruise control including Porsche Active Safe (PAS)	<input type="checkbox"/>	<input type="checkbox"/>	<input type="checkbox"/>	<input type="checkbox"/>	<input type="checkbox"/>	<input type="checkbox"/>	<input type="checkbox"/>	456	102
Lane Change Assist	<input type="checkbox"/>	<input type="checkbox"/>	<input type="checkbox"/>	<input type="checkbox"/>	<input type="checkbox"/>	<input type="checkbox"/>	<input type="checkbox"/>	457	104, 105
Lane Departure Warning	<input type="checkbox"/>	<input type="checkbox"/>	<input type="checkbox"/>	<input type="checkbox"/>	<input type="checkbox"/>	<input type="checkbox"/>	<input type="checkbox"/>	458	105
Speed limit indicator	<input type="checkbox"/>	<input type="checkbox"/>	<input type="checkbox"/>	<input type="checkbox"/>	<input type="checkbox"/>	<input type="checkbox"/>	<input type="checkbox"/>	631	104, 105
Soft close doors	<input type="checkbox"/>	<input type="checkbox"/>	<input type="checkbox"/>	<input type="checkbox"/>	<input type="checkbox"/>	<input type="checkbox"/>	<input type="checkbox"/>	885	87
Driver memory package	<input type="checkbox"/>	<input type="checkbox"/>	<input type="checkbox"/>	<input type="checkbox"/>	<input type="checkbox"/>	<input type="checkbox"/>	<input type="checkbox"/>	537	88
14-way power seats including memory package	<input type="checkbox"/>	<input type="checkbox"/>	<input type="checkbox"/>	<input type="checkbox"/>	<input type="checkbox"/>	<input type="checkbox"/>	<input checked="" type="checkbox"/>	P80	130
8-way power seats including memory package						<input type="checkbox"/>	<input type="checkbox"/>	P80	130
Adaptive Sports seats with memory package	<input type="checkbox"/>	<input type="checkbox"/>	<input type="checkbox"/>	<input type="checkbox"/>	<input type="checkbox"/>	<input checked="" type="checkbox"/>	<input type="checkbox"/>	P81	88
8-way power seats (rear)	<input type="checkbox"/>	<input type="checkbox"/>	<input type="checkbox"/>	<input type="checkbox"/>	<input type="checkbox"/>	<input type="checkbox"/>	<input type="checkbox"/>	834	90, 91
8-way power seats (rear) with comfort headrests	<input type="checkbox"/>	<input type="checkbox"/>	<input type="checkbox"/>	<input type="checkbox"/>	<input type="checkbox"/>	<input type="checkbox"/>	<input type="checkbox"/>	834	90, 91
8-way power seats (rear) (in conjunction with large centre console)	<input type="checkbox"/>	<input type="checkbox"/>	<input type="checkbox"/>	<input type="checkbox"/>	<input type="checkbox"/>	<input type="checkbox"/>	<input type="checkbox"/>	836	90
8-way power seats (rear) (in conjunction with large centre console) with comfort headrests	<input type="checkbox"/>	<input type="checkbox"/>	<input type="checkbox"/>	<input type="checkbox"/>	<input type="checkbox"/>	<input type="checkbox"/>	<input type="checkbox"/>	836	90
8-way power seats (rear) (in conjunction with adaptive Sports seats)	<input type="checkbox"/>	<input type="checkbox"/>	<input type="checkbox"/>	<input type="checkbox"/>	<input type="checkbox"/>	<input type="checkbox"/>	<input type="checkbox"/>	835	91
Folding table in rear	<input type="checkbox"/>	<input type="checkbox"/>	<input type="checkbox"/>	<input type="checkbox"/>	<input type="checkbox"/>	<input type="checkbox"/>	<input type="checkbox"/>	P86	
Seat heating (front)	<input type="checkbox"/>	<input type="checkbox"/>	<input checked="" type="checkbox"/>	<input checked="" type="checkbox"/>	<input checked="" type="checkbox"/>	<input checked="" type="checkbox"/>	<input type="checkbox"/>	342	91
Seat heating (front and rear)	<input type="checkbox"/>	<input type="checkbox"/>	<input type="checkbox"/>	<input type="checkbox"/>	<input type="checkbox"/>	<input type="checkbox"/>	<input checked="" type="checkbox"/>	343	91
Seat ventilation (front)	<input type="checkbox"/>	<input type="checkbox"/>	<input type="checkbox"/>	<input type="checkbox"/>	<input type="checkbox"/>	<input type="checkbox"/>	<input type="checkbox"/>	541	91
Seat ventilation (front and rear)	<input type="checkbox"/>	<input type="checkbox"/>	<input type="checkbox"/>	<input type="checkbox"/>	<input type="checkbox"/>	<input type="checkbox"/>	<input type="checkbox"/>	542	91



14-way power seats with memory package

The vehicles illustrated in the chapter on personalisation may include additional options not featured in this catalogue. For information on these options, please consult your Porsche Centre. For detailed information on specific optional equipment and packages, please refer to the separate price list.

- not available
- I number/extra-cost option
- standard equipment
- available at no extra cost

Option	Panamera	Panamera 4	Panamera S	Panamera 4S	Panamera S E-Hybrid	Panamera GTS	Panamera Turbo	I no.	Page
Interior.									
ISOFIX child seat mounting points on front passenger seat	<input type="checkbox"/>	<input type="checkbox"/>	<input type="checkbox"/>	<input type="checkbox"/>	<input type="checkbox"/>	<input type="checkbox"/>	<input type="checkbox"/>	899	88
Interior lighting package for rear compartment	<input type="checkbox"/>	<input type="checkbox"/>	<input type="checkbox"/>	<input type="checkbox"/>	<input type="checkbox"/>	<input type="checkbox"/>	<input type="checkbox"/>	630	86, 87
Multifunction steering wheel	<input checked="" type="checkbox"/>	<input checked="" type="checkbox"/>	<input checked="" type="checkbox"/>	<input checked="" type="checkbox"/>	<input type="checkbox"/>	<input checked="" type="checkbox"/>	<input type="checkbox"/>	844	62
SportDesign steering wheel	<input type="checkbox"/>	<input type="checkbox"/>	<input type="checkbox"/>	<input type="checkbox"/>	<input type="checkbox"/>	<input checked="" type="checkbox"/>	<input type="checkbox"/>	840	62
Auxiliary heating system	<input type="checkbox"/>	<input type="checkbox"/>	<input type="checkbox"/>	<input type="checkbox"/>	<input type="checkbox"/>	<input type="checkbox"/>	<input type="checkbox"/>	851	
Auxiliary air conditioning*	<input type="checkbox"/>	<input type="checkbox"/>	<input type="checkbox"/>	<input type="checkbox"/>	<input type="checkbox"/>	<input type="checkbox"/>	<input type="checkbox"/>	854	
Steering wheel heating	<input type="checkbox"/>	<input type="checkbox"/>	<input type="checkbox"/>	<input type="checkbox"/>	<input type="checkbox"/>	<input type="checkbox"/>	<input type="checkbox"/>	345	
Two fold-out cupholders above glove compartment	<input type="checkbox"/>	<input type="checkbox"/>	<input type="checkbox"/>	<input type="checkbox"/>	<input type="checkbox"/>	<input type="checkbox"/>	<input type="checkbox"/>	585	84
Four-zone automatic climate control	<input type="checkbox"/>	<input type="checkbox"/>	<input type="checkbox"/>	<input type="checkbox"/>	<input type="checkbox"/>	<input type="checkbox"/>	<input type="checkbox"/>	576	87
Large rear centre console	<input type="checkbox"/>	<input type="checkbox"/>	<input type="checkbox"/>	<input type="checkbox"/>	<input type="checkbox"/>	<input type="checkbox"/>	<input type="checkbox"/>	838	84, 90
Side airbags in rear	<input type="checkbox"/>	<input type="checkbox"/>	<input type="checkbox"/>	<input type="checkbox"/>	<input type="checkbox"/>	<input type="checkbox"/>	<input type="checkbox"/>	565	78
Electric roll-up sunblind for behind rear compartment	<input type="checkbox"/>	<input type="checkbox"/>	<input type="checkbox"/>	<input type="checkbox"/>	<input type="checkbox"/>	<input type="checkbox"/>	<input type="checkbox"/>	862	87, 131
Electric roll-up sunblind for rear side windows	<input type="checkbox"/>	<input type="checkbox"/>	<input type="checkbox"/>	<input type="checkbox"/>	<input type="checkbox"/>	<input type="checkbox"/>	<input type="checkbox"/>	861	87
Ski bag	<input type="checkbox"/>	<input type="checkbox"/>	<input type="checkbox"/>	<input type="checkbox"/>	<input type="checkbox"/>	<input type="checkbox"/>	<input type="checkbox"/>	213	90, 109
Fixed luggage compartment cover	<input type="checkbox"/>	<input type="checkbox"/>	<input type="checkbox"/>	<input type="checkbox"/>	<input type="checkbox"/>	<input type="checkbox"/>	<input type="checkbox"/>	869	109
HomeLink® (programmable garage door opener)	<input type="checkbox"/>	<input type="checkbox"/>	<input type="checkbox"/>	<input type="checkbox"/>	<input type="checkbox"/>	<input type="checkbox"/>	<input type="checkbox"/>	608	
Fire extinguisher	<input type="checkbox"/>	<input type="checkbox"/>	<input type="checkbox"/>	<input type="checkbox"/>	<input type="checkbox"/>	<input type="checkbox"/>	<input type="checkbox"/>	509	
Floor mats	<input type="checkbox"/>	<input type="checkbox"/>	<input type="checkbox"/>	<input type="checkbox"/>	<input type="checkbox"/>	<input type="checkbox"/>	<input type="checkbox"/>	810	

* With E-Mobility Services, you can remotely activate the climate control system of your vehicle as desired.



Large centre console in rear



Roll-up sunblind



Interior in two-tone combination (Marsala and Cream), interior package in black (high-gloss) and other optional equipment



Interior in Cognac natural leather, Yachting Mahogany interior package and other optional equipment



Interior in Luxor Beige, dark walnut interior package and other optional equipment

Option

Interior: black (high-gloss).

Interior package in black (high-gloss)

Interior: leather.

Standard leather interior for Panamera in standard colours

Partial leather interior package for Panamera in two-tone combination (Black and Luxor Beige)

Leather interior package for Panamera in standard colours, smooth-finish leather

Leather interior package for Panamera in standard colours, smooth-finish leather including Alcantara GTS package

Interior package GTS in GT Silver

Interior package GTS in Carmine Red

Leather interior package in two-tone combination

Leather interior package in natural leather

Soft ruffled leather on seats (in conjunction with standard interior)

Soft ruffled leather on seats (in conjunction with leather interior)

Interior: Alcantara.

Roof lining in Alcantara

SportDesign steering wheel with rim in Alcantara

Option	Panamera	Panamera 4	Panamera S	Panamera 4S	Panamera S E-Hybrid	Panamera GTS	Panamera Turbo	I no.	Page
Interior package in black (high-gloss)	•	•	•	•	•	□	□	817	120, 132
Interior: leather.									
Standard leather interior for Panamera in standard colours	•	•	•	•	•	–	–	Code	116
Partial leather interior package for Panamera in two-tone combination (Black and Luxor Beige)	○	○	○	○	○	–	–	Code	
Leather interior package for Panamera in standard colours, smooth-finish leather	○	○	○	○	○	□	•	Code	
Leather interior package for Panamera in standard colours, smooth-finish leather including Alcantara GTS package	–	–	–	–	–	•	–	Code	43
Interior package GTS in GT Silver	–	–	–	–	–	○	–	GS	
Interior package GTS in Carmine Red	–	–	–	–	–	○	–	GK	42
Leather interior package in two-tone combination	○	○	○	○	○	○	○	Code	117, 132
Leather interior package in natural leather	○	○	○	○	○	○	○	Code	118
Soft ruffled leather on seats (in conjunction with standard interior)	○	○	○	○	○	–	–	947	
Soft ruffled leather on seats (in conjunction with leather interior)	○	○	○	○	○	○	○	982	
Interior: Alcantara.									
Roof lining in Alcantara	○	○	○	○	○	•	•	594	
SportDesign steering wheel with rim in Alcantara	○	○	○	○	○	○	○	843	

The vehicles illustrated in the chapter on personalisation may include additional options not featured in this catalogue. For information on these options, please consult your Porsche Centre. For detailed information on specific optional equipment and packages, please refer to the separate price list.

– not available ○ I number/extra-cost option • standard equipment □ available at no extra cost

Option	Panamera	Panamera 4	Panamera S	Panamera 4S	Panamera S E-Hybrid	Panamera GTS	Panamera Turbo	I no.	Page
Interior: wood.									
Dark walnut interior package	<input type="checkbox"/>	<input type="checkbox"/>	<input type="checkbox"/>	<input type="checkbox"/>	<input type="checkbox"/>	<input type="checkbox"/>	<input checked="" type="checkbox"/>	826	132
Heated multifunction steering wheel in dark walnut	<input type="checkbox"/>	<input type="checkbox"/>	<input type="checkbox"/>	<input type="checkbox"/>	<input type="checkbox"/>	<input type="checkbox"/>	<input type="checkbox"/>	837	
Tineo interior package	<input type="checkbox"/>	<input type="checkbox"/>	<input type="checkbox"/>	<input type="checkbox"/>	<input type="checkbox"/>	<input type="checkbox"/>	<input type="checkbox"/>	822	135
Heated multifunction steering wheel in tineo	<input type="checkbox"/>	<input type="checkbox"/>	<input type="checkbox"/>	<input type="checkbox"/>	<input type="checkbox"/>	<input type="checkbox"/>	<input type="checkbox"/>	849	
Anthracite birch interior package	<input type="checkbox"/>	<input type="checkbox"/>	<input type="checkbox"/>	<input type="checkbox"/>	<input type="checkbox"/>	<input type="checkbox"/>	<input type="checkbox"/>	823	135
Heated multifunction steering wheel in anthracite birch	<input type="checkbox"/>	<input type="checkbox"/>	<input type="checkbox"/>	<input type="checkbox"/>	<input type="checkbox"/>	<input type="checkbox"/>	<input type="checkbox"/>	848	
Natural olive interior package	<input type="checkbox"/>	<input type="checkbox"/>	<input type="checkbox"/>	<input type="checkbox"/>	<input type="checkbox"/>	<input type="checkbox"/>	<input type="checkbox"/>	824	135
Yachting Mahogany interior package	<input type="checkbox"/>	<input type="checkbox"/>	<input type="checkbox"/>	<input type="checkbox"/>	<input type="checkbox"/>	<input type="checkbox"/>	<input type="checkbox"/>	XZY	132
Exclusive									
Heated multifunction steering wheel in Yachting Mahogany	<input type="checkbox"/>	<input type="checkbox"/>	<input type="checkbox"/>	<input type="checkbox"/>	<input type="checkbox"/>	<input type="checkbox"/>	<input type="checkbox"/>	XZZ	132
Exclusive									
Interior: carbon.									
Carbon interior package	<input type="checkbox"/>	<input type="checkbox"/>	<input type="checkbox"/>	<input type="checkbox"/>	<input type="checkbox"/>	<input type="checkbox"/>	<input checked="" type="checkbox"/>	819	12
Heated multifunction steering wheel in carbon	<input type="checkbox"/>	<input type="checkbox"/>	<input type="checkbox"/>	<input type="checkbox"/>	<input type="checkbox"/>	<input type="checkbox"/>	<input type="checkbox"/>	845	
Interior: aluminium.									
Brushed aluminium interior package	<input type="checkbox"/>	<input type="checkbox"/>	<input type="checkbox"/>	<input type="checkbox"/>	<input type="checkbox"/>	<input type="checkbox"/>	<input type="checkbox"/>	818	36
Additional door sill guards in brushed aluminium	<input type="checkbox"/>	<input type="checkbox"/>	<input type="checkbox"/>	<input type="checkbox"/>	<input type="checkbox"/>	<input type="checkbox"/>	<input type="checkbox"/>	597	

The vehicles illustrated in the chapter on personalisation may include additional options not featured in this catalogue. For information on these options, please consult your Porsche Centre. For detailed information on specific optional equipment and packages, please refer to the separate price list.

– not available I number/extra-cost option • standard equipment available at no extra cost



Interior in two-tone combination (Black and Cream), anthracite birch interior package and other optional equipment



Interior in two-tone combination (Luxor Beige and Cream), natural olive interior package and other optional equipment



Interior in Espresso, tineo interior package and other optional equipment

Option	Panamera	Panamera 4	Panamera S	Panamera 4S	Panamera S E-Hybrid	Panamera GTS	Panamera Turbo	I no.	Page
Audio and communication options for vehicles with CDR audio system.									
CDR Plus audio system	<input type="checkbox"/>	<input type="checkbox"/>	<input type="checkbox"/>	<input type="checkbox"/>	<input type="checkbox"/>	<input type="checkbox"/>	<input type="checkbox"/>	P87	92
Six-disc CD autochanger ¹⁾	<input type="checkbox"/>	<input type="checkbox"/>	<input type="checkbox"/>	<input type="checkbox"/>	<input type="checkbox"/>	<input type="checkbox"/>	<input type="checkbox"/>	692	92
Universal audio interface (AUX)	<input type="checkbox"/>	<input type="checkbox"/>	<input type="checkbox"/>	<input type="checkbox"/>	<input type="checkbox"/>	<input type="checkbox"/>	<input type="checkbox"/>	870	95
BOSE® Surround Sound System	<input type="checkbox"/>	<input type="checkbox"/>	<input type="checkbox"/>	<input type="checkbox"/>	<input type="checkbox"/>	<input type="checkbox"/>	<input type="checkbox"/>	680	98
Burmester® High-End Surround Sound System	<input type="checkbox"/>	<input type="checkbox"/>	<input type="checkbox"/>	<input type="checkbox"/>	<input type="checkbox"/>	<input type="checkbox"/>	<input type="checkbox"/>	682	98
Mobile phone preparation ^{3), 4)}	<input type="checkbox"/>	<input type="checkbox"/>	<input type="checkbox"/>	<input type="checkbox"/>	<input type="checkbox"/>	<input type="checkbox"/>	<input type="checkbox"/>	619	97



Burmester® High-End Surround Sound System



BOSE® Surround Sound System

¹⁾ May be incompatible with some copy-protected CDs.

²⁾ For the reception of analogue and digital television signals (DVB-T) – if available.

³⁾ For information on compatible mobile phones, please visit www.porsche.com or contact your Porsche Centre.

⁴⁾ Mobile phone preparation or telephone module in HFP mode: the use of a mobile phone inside a car may cause an increase in the interior electromagnetic field strength and, accordingly, in the electromagnetic radiation to which passengers are exposed. If a cradle is used to mount the mobile phone, the field strength in the passenger compartment can be reduced because the phone can be connected to the external aerial (feature depends on how specific mobile phones connect to the cradle). For information about the availability of a cradle for your mobile phone, please consult an accessories supplier. The use of the telephone module for PCM via Bluetooth® SAP connection or with inserted SIM card prevents exposure to electromagnetic radiation as only the car's external aerial is ever used.

Option

Audio and communication options for vehicles with PCM.

Option	Panamera	Panamera 4	Panamera S	Panamera 4S	Panamera S E-Hybrid	Panamera GTS	Panamera Turbo	I no.	Page
Audio and communication options for vehicles with PCM.									
Porsche Communication Management (PCM) including navigation module ¹⁾	<input type="checkbox"/>	<input type="checkbox"/>	<input type="checkbox"/>	<input type="checkbox"/>	<input type="checkbox"/>	<input type="checkbox"/>	<input checked="" type="checkbox"/>	P23	35, 92
Six-disc CD/DVD autochanger ¹⁾	<input type="checkbox"/>	<input type="checkbox"/>	<input type="checkbox"/>	<input type="checkbox"/>	<input type="checkbox"/>	<input type="checkbox"/>	<input type="checkbox"/>	693	92
Universal audio interface (AUX, USB, e.g. for iPod®)	<input type="checkbox"/>	<input type="checkbox"/>	<input type="checkbox"/>	<input type="checkbox"/>	<input type="checkbox"/>	<input type="checkbox"/>	<input type="checkbox"/>	870	95
BOSE® Surround Sound System	<input type="checkbox"/>	<input type="checkbox"/>	<input type="checkbox"/>	<input type="checkbox"/>	<input type="checkbox"/>	<input type="checkbox"/>	<input checked="" type="checkbox"/>	680	98
Burmester® High-End Surround Sound System	<input type="checkbox"/>	<input type="checkbox"/>	<input type="checkbox"/>	<input type="checkbox"/>	<input type="checkbox"/>	<input type="checkbox"/>	<input type="checkbox"/>	682	98
Mobile phone preparation ^{3), 4)}	<input type="checkbox"/>	<input type="checkbox"/>	<input type="checkbox"/>	<input type="checkbox"/>	<input type="checkbox"/>	<input type="checkbox"/>	<input type="checkbox"/>	619	97
Telephone module with Bluetooth® handset	<input type="checkbox"/>	<input type="checkbox"/>	<input type="checkbox"/>	<input type="checkbox"/>	<input type="checkbox"/>	<input type="checkbox"/>	<input type="checkbox"/>	669	96
Online services	<input type="checkbox"/>	<input type="checkbox"/>	<input type="checkbox"/>	<input type="checkbox"/>	<input type="checkbox"/>	<input type="checkbox"/>	<input type="checkbox"/>	UN1	97
Porsche Car Connect	<input type="checkbox"/>	<input type="checkbox"/>	<input type="checkbox"/>	<input type="checkbox"/>	<input checked="" type="checkbox"/>	<input type="checkbox"/>	<input type="checkbox"/>	7G9	
Porsche Car Connect including Porsche Vehicle Tracking System Plus (PVTs Plus)	<input type="checkbox"/>	<input type="checkbox"/>	<input type="checkbox"/>	<input type="checkbox"/>	<input type="checkbox"/>	<input type="checkbox"/>	<input type="checkbox"/>	7I2	
Porsche Rear Seat Entertainment Plus	<input type="checkbox"/>	<input type="checkbox"/>	<input type="checkbox"/>	<input type="checkbox"/>	<input type="checkbox"/>	<input type="checkbox"/>	<input type="checkbox"/>	CHS	94, 95
Exclusive									
Additional charging cradle for Bluetooth® handset in rear compartment	<input type="checkbox"/>	<input type="checkbox"/>	<input type="checkbox"/>	<input type="checkbox"/>	<input type="checkbox"/>	<input type="checkbox"/>	<input type="checkbox"/>	626	
TV tuner ²⁾	<input type="checkbox"/>	<input type="checkbox"/>	<input type="checkbox"/>	<input type="checkbox"/>	<input type="checkbox"/>	<input type="checkbox"/>	<input type="checkbox"/>	676	93
Voice control system	<input type="checkbox"/>	<input type="checkbox"/>	<input type="checkbox"/>	<input type="checkbox"/>	<input type="checkbox"/>	<input type="checkbox"/>	<input type="checkbox"/>	671	95
Electronic logbook	<input type="checkbox"/>	<input type="checkbox"/>	<input type="checkbox"/>	<input type="checkbox"/>	<input type="checkbox"/>	<input type="checkbox"/>	<input type="checkbox"/>	641	96

The vehicles illustrated in the chapter on personalisation may include additional options not featured in this catalogue. For information on these options, please consult your Porsche Centre. For detailed information on specific optional equipment and packages, please refer to the separate price list.

– not available I number/extra-cost option • standard equipment available at no extra cost



TV tuner



Six-disc CD/DVD autochanger



Porsche Exclusive.

**Our cars are state of the art.
And made to measure.**

With the range of options featured in this catalogue, you can make your Porsche even more special. Introducing Porsche Exclusive. Have your vehicle individually

and exclusively tailored to your wishes, even before it leaves the factory. Aesthetically and technically, inside and outside, using fine materials and with customary Porsche quality.

Our overriding principle? To ensure that your car is uniquely handcrafted to your taste. You will find a wide range of design options in the separate Porsche Exclusive Panamera catalogue.

Either your Porsche Centre or the Customer Centre in Zuffenhausen (e-mail customercenter-exclusive@porsche.de or telephone +49 711 911-25977) will be happy to answer any questions you may have about Porsche Exclusive.

Porsche Car Configurator.

Taste, personality and style. You decide how to refine the Panamera to your personal preference. With the Porsche Car Configurator, you can see the result instantly on your computer. Just four steps are all it takes to create your own Porsche.

It's as simple as selecting or deselecting the options you want. The price is recalculated automatically with each click. It looks stunning, because the features are rendered in 3D. So you can view your configuration from any angle, save it and print it off there and then.

Visit www.porsche.com to access the Porsche Car Configurator and experience the fascinating world of Porsche.

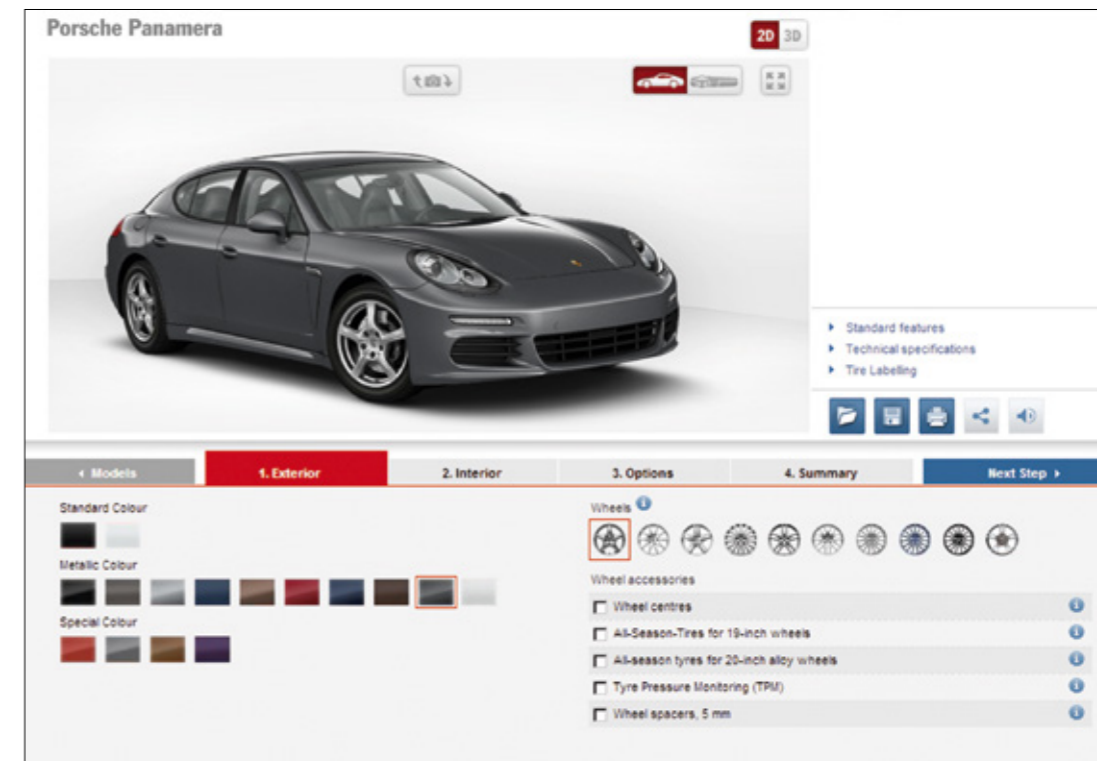

Porsche Driving Experience.

Porsche Sport Driving School.

At Porsche, we don't just concentrate on the evolution of the sports car – but also on the development of its drivers. It's easy enough to drive a vehicle safely on the road. But what about mastering a sports car within its dynamic limits? We help you to develop your driving safety, and gradually optimise and perfect your driving skills.

Under the guidance of our experienced Porsche instructors. In your own vehicle or one owned by the Porsche Sport Driving School. On-road or off-road. On international racetracks. On snow or ice. We accompany you right from the start and guide you – if you wish – through the various training levels right through to being awarded your motorsport licence.

To find out more, go to www.porsche.de/sportdrivingschool

Porsche Travel Club.

With the Porsche Travel Club, your holiday starts right from the first second – when you get in the car. Leave your troubles behind and accompany us to some of the most beautiful regions in the world. Be our guest. For a few hours or a few days; but always with an impressive companion – a Porsche. A unique experience, rounded off by an exclusive

supporting programme: you stay overnight in first-class hotels and dine in the best restaurants located along the route. In short: with the Porsche Travel Club you can experience something that you just cannot describe in words: the true driving feel of a Porsche.

To find out more, go to www.porsche.de/travelclub



Factory collection.

The first time that you drive your new Porsche will be a truly special moment. Nevertheless, you can make it even more special with Porsche factory collection. Come and collect your Porsche in Stuttgart-Zuffenhausen or Leipzig and be the one to take it to its rightful place: on the road.

Before this, we invite you behind the scenes of the Porsche production process. As part of a guided factory tour, you will see how much passion and

precision goes into everything we do. You can then take time to reflect on your experience over a leisurely lunch and look forward to the high point of the day: taking delivery of your Porsche. Our specialists will take their time to explain everything about your new car in as much detail as you wish.

That leaves you with just one more thing to decide: from which factory to collect your Porsche? Stuttgart-Zuffenhausen is steeped in tradition and history.

Here, you can visit the Porsche Museum to experience and learn about every aspect of the Porsche marque, with legendary models from a sports car history spanning over 60 years.

Or, if you would prefer your factory collection to be a little more on the sporty side, visit our production location in Leipzig. Your first driving experience will be a test drive in a Porsche model identical to the one you purchased and under the expert supervision of one of

our instructors. Hone your skills on-road on the FIA-certified circuit or off-road in a Porsche off-roader on our very own off-road track.

If you do opt for the factory collection, please contact your Porsche Centre to arrange a collection date. We will be happy to assist in the planning of your trip. You will also be given information on the formalities, legal or otherwise, to be completed before you can take delivery.





Porsche Centres

Your Porsche Centre can assist you with every aspect of purchasing and owning your Porsche. You will also find a wide range of products and services, including genuine Porsche parts and top-quality accessories.



Porsche Exclusive

Realise your vision of the perfect Porsche with our factory customisation programme. From styling enhancements to performance upgrades, all modifications are uniquely handcrafted for your Porsche.



Porsche Tequipment

Personalise your Porsche at any time after purchase with our range of aftermarket accessories. You will also find all our available products online at www.porsche.com/tequipment using the Tequipment accessories finder.



Porsche Driver's Selection

With products ranging from fashion and accessories to tailored luggage, this unique collection combines quality and style with everyday practicality.



Porsche Travel Club

Embark on a thrilling adventure and feel the power of Porsche. Stay in top-class hotels and dine in five-star restaurants. Worldwide. To find out more, call +49 711 911-23360. E-mail: info@porschetravelclub.de



Porsche Sport Driving School

Develop your skill and explore your Porsche with the Porsche Sport Driving School. Learn about events at some of the world's most famous racing venues, call +49 711 911-23364. E-mail: info@porscheporstdrivingsschool.de



Porsche Clubs

Since the first Porsche Club was founded in 1952, their number has grown to 651 with a total of 186,000 members worldwide. To find out more, go to www.porsche.com/clubs or call +49 711 911-23250.

Panorama.

Porsche Service

Your expert partner for all current Porsche models as well as old and modern classics, whether your car needs servicing, routine care or special repairs.

Porsche Assistance

Enjoy peace of mind with our exclusive breakdown and accident recovery service. Membership is free when you buy a new Porsche.

Porsche Approved

So that our vehicles remain reliable and retain their value whether new or previously owned, all Porsche Approved cars meet the most stringent Porsche quality standards across the world. Each car is backed by the Porsche Approved warranty.

Porsche Financial Services

Our range of financial services is innovative and specially tailored to the needs of Porsche owners. Products range from attractive finance and leasing options to vehicle insurance and the Porsche Card.

Christophorus

Published five times a year, our magazine for Porsche owners offers news, interviews and a variety of features from throughout the world of Porsche. Visit www.porsche.com/christophorus for a selection of online articles.

Porsche Classic

Your specialist source for genuine Porsche parts as well as restoration services for all Porsche classics. Visit www.porsche.com/classic to find out more.

Porsche Museum

More than 80 vehicles at our headquarters in Stuttgart-Zuffenhausen await to take you on a journey through Porsche history. See icons such as the 356, 911 and 917 presented in an atmosphere you can't experience anywhere else.

Porsche Online

Go to www.porsche.com for all the latest news and information from Porsche.

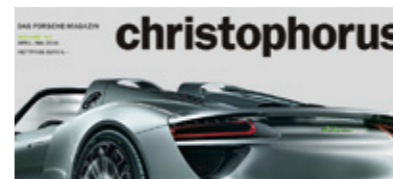

You can obtain the latest brochures for Porsche Exclusive, Porsche Tequipment, Porsche Driver's Selection and Porsche Driving Experience from your Porsche Centre.



Decision and horizon. Summary.

Sometimes one life is not enough. There is so much to see and do. Then again, why couldn't we live two lives at once? Why couldn't we, for example, sit in a saloon and drive a sports car at the same time? Couldn't we opt for a sustainable solution without sacrificing driving pleasure? It is these contradictions that make life so fascinating. The new Panamera models draw strength from a powerful force: thrilling contradictions. For the next horizon.

	Panamera	Panamera 4
Engine		
Cylinders	6	6
Displacement	3,605 cm ³	3,605 cm ³
Max. power (DIN) at rpm	228 kW (310 hp) at 6,200	228 kW (310 hp) at 6,200
Max. torque at rpm	400 Nm at 3,750	400 Nm at 3,750
Compression ratio	12.5:1	12.5:1
Transmission		
Layout	Rear-wheel drive	All-wheel drive
PDK (7-speed)	Standard	Standard
Tiptronic S (8-speed)	–	–
Chassis		
Front axle	Aluminium double-wishbone	Aluminium double-wishbone
Rear axle	Aluminium multi-link with chassis subframe	Aluminium multi-link with chassis subframe
Steering	Hydraulic power steering	Hydraulic power steering
Brakes	Six-piston monobloc aluminium fixed calipers (front), four-piston monobloc aluminium fixed calipers (rear), integral brake discs internally vented and cross-drilled	Six-piston monobloc aluminium fixed calipers (front), four-piston monobloc aluminium fixed calipers (rear), integral brake discs internally vented and cross-drilled
Standard wheels	Front: 8 J x 18 ET 59, Rear: 9 J x 18 ET 53	Front: 8 J x 18 ET 59, Rear: 9 J x 18 ET 53
Standard tyres	Front: 245/50 ZR 18, Rear: 275/45 ZR 18	Front: 245/50 ZR 18, Rear: 275/45 ZR 18

	Panamera S	Panamera 4S
Engine		
Cylinders	6	6
Displacement	2,997 cm ³	2,997 cm ³
Max. power (DIN) at rpm	309 kW (420 hp) at 6,000	309 kW (420 hp) at 6,000
Max. torque at rpm	520 Nm between 1,750 and 5,000	520 Nm between 1,750 and 5,000
Compression ratio	9.8:1	9.8:1
Transmission		
Layout	Rear-wheel drive	All-wheel drive
PDK (7-speed)	Standard	Standard
Tiptronic S (8-speed)	–	–
Chassis		
Front axle	Aluminium double-wishbone	Aluminium double-wishbone
Rear axle	Aluminium multi-link with chassis subframe	Aluminium multi-link with chassis subframe
Steering	Hydraulic power steering	Hydraulic power steering
Brakes	Six-piston monobloc aluminium fixed calipers (front), four-piston monobloc aluminium fixed calipers (rear), integral brake discs internally vented and cross-drilled	Six-piston monobloc aluminium fixed calipers (front), four-piston monobloc aluminium fixed calipers (rear), integral brake discs internally vented and cross-drilled
Standard wheels	Front: 8 J x 18 ET 59, Rear: 9 J x 18 ET 53	Front: 8 J x 18 ET 59, Rear: 9 J x 18 ET 53
Standard tyres	Front: 245/50 ZR 18, Rear: 275/45 ZR 18	Front: 245/50 ZR 18, Rear: 275/45 ZR 18

	Panamera S E-Hybrid	Panamera GTS
Engine		
Cylinders	6	8
Displacement	2,995 cm ³	4,806 cm ³
Max. power (DIN) at rpm	245 kW (333 hp) between 5,500 and 6,500	324 kW (440 hp) at 6,700
Max. torque at rpm	440 Nm between 3,000 and 5,250	520 Nm at 3,500
Compression ratio	10.5:1	12.5:1
Max. power electric motor at rpm	70 kW (95 hp) between 2,200 and 2,600	–
Max. torque electric motor at rpm	310 Nm < 1,700	–
Max. power parallel full hybrid at rpm	306 kW (416 hp) at 5,500	–
Max. torque parallel full hybrid at rpm	590 Nm between 1,250 and 4,000	–
Transmission		
Layout	Rear-wheel drive	All-wheel drive
PDK (7-speed)	–	Standard
8-speed Tiptronic S	Standard	–
Chassis		
Front axle	Aluminium double-wishbone	Aluminium double-wishbone
Rear axle	Aluminium multi-link with chassis subframe	Aluminium multi-link with chassis subframe
Steering	Hydraulic power steering	Hydraulic power steering
Brakes	Six-piston monobloc aluminium fixed calipers (front), four-piston monobloc aluminium fixed calipers (rear), integral brake discs internally vented and cross-drilled	Six-piston monobloc aluminium fixed calipers (front), four-piston monobloc aluminium fixed calipers (rear), composite brake discs (front), integral brake discs (rear), internally vented and cross-drilled
Standard wheels	Front: 8 J x 18 ET 59, Rear: 9 J x 18 ET 53	Front: 9 J x 19 ET 60, Rear: 10 J x 19 ET 61
Standard tyres	Front: 245/50 ZR 18, Rear: 275/45 ZR 18	Front: 255/45 ZR 19, Rear: 285/40 ZR 19

	Panamera Turbo
Engine	
Cylinders	8
Displacement	4,806 cm ³
Max. power (DIN) at rpm	382 kW (520 hp) at 6,000
Max. torque at rpm	700 Nm between 2,250 and 4,500
Compression ratio	10.5:1
Max. power electric motor at rpm	–
Max. torque electric motor at rpm	–
Max. power parallel full hybrid at rpm	–
Max. torque parallel full hybrid at rpm	–
Transmission	
Layout	All-wheel drive
PDK (7-speed)	Standard
Tiptronic S (8-speed)	–
Chassis	
Front axle	Aluminium double-wishbone
Rear axle	Aluminium multi-link with chassis subframe
Steering	Hydraulic power steering
Brakes	Six-piston monobloc aluminium fixed calipers (front), four-piston monobloc aluminium fixed calipers (rear), composite brake discs (front), integral brake discs (rear), internally vented and cross-drilled
Standard wheels	Front: 9 J x 19 ET 60, Rear: 10 J x 19 ET 61
Standard tyres	Front: 255/45 ZR 19, Rear: 285/40 ZR 19

	Panamera	Panamera 4	Panamera S	Panamera 4S
Weights				
Unladen weight (DIN)	1,770 kg	1,820 kg	1,810 kg	1,870 kg
Unladen (EC) ¹⁾	1,845 kg	1,895 kg	1,885 kg	1,945 kg
Permissible gross weight	2,380 kg	2,420 kg	2,415 kg	2,450 kg
Max. additional load	610 kg	600 kg	605 kg	580 kg
Performance				
Top speed	259 km/h	257 km/h	287 km/h	286 km/h
0–100 km/h	6.3 secs (6.0 secs) ²⁾	6.1 secs (5.8 secs) ²⁾	5.1 secs (4.8 secs) ²⁾	4.8 secs (4.5 secs) ²⁾
Overtaking acceleration 80–120 km/h	4.3 secs	4.4 secs	2.9 secs	3.0 secs
Fuel consumption/emissions^{3)/} efficiency classes⁴⁾				
Fuel grade	Super Plus unleaded (RON 98)	Super Plus unleaded (RON 98)	Super Plus unleaded (RON 98)	Super Plus unleaded (RON 98)
Urban (in l/100 km)	11.4	11.6	12.1	12.4
Extra urban (in l/100 km)	6.9	7.2	7.1	7.3
Combined (in l/100 km)	8.5	8.8	8.9	9.1
CO ₂ emissions g/km	199	206	207	211
Combined power consumption (in kWh/100 km)	–	–	–	–
Efficiency class (Germany) ⁴⁾	D	E	E	E
Efficiency class (Switzerland) ⁴⁾	G	G	G	G
Dimensions				
Length	5,015 mm	5,015 mm	5,015 mm	5,015 mm
Width (with exterior mirrors)	1,931 mm (2,114 mm)	1,931 mm (2,114 mm)	1,931 mm (2,114 mm)	1,931 mm (2,114 mm)
Height	1,418 mm	1,418 mm	1,418 mm	1,418 mm
Wheelbase	2,920 mm	2,920 mm	2,920 mm	2,920 mm
Luggage compartment volume (German Car Manufacturers' Assoc.) with folded down rear seats	445 litres	445 litres	445 litres	445 litres
Tank capacity	80 litres	80 litres	80 litres	100 litres











¹⁾ In accordance with the EC standard, the unladen weight applies to vehicles with standard specification only. Optional equipment increases this figure. The figure given includes 68 kg for the driver and 7 kg for luggage.

²⁾ In conjunction with the optional Sport Chrono Package with activated SPORT PLUS button selected (in the Panamera GTS series).



³⁾ Data determined in the NEDC (New European Driving Cycle) in accordance with the Euro 6 (715/2007/EC, 195/2013/EC and ECE-R 101.01) measurement method. The figures do not refer to an individual vehicle nor do they constitute part of the offer. They are intended solely as a means of comparing different types of vehicle. Fuel consumption calculated for vehicles with standard specification only. Optional equipment may affect fuel consumption and performance. A vehicle's fuel consumption and CO₂ emissions do not just depend on how efficiently the vehicle uses the fuel but also on driving style and other non-technical factors. The latest Porsche models with petrol engines are designed to operate on fuels with an ethanol content of up to 10%. You can obtain the latest information on individual vehicles from your Porsche Centre.

⁴⁾ Valid in the countries listed only.

	Panamera S E-Hybrid	Panamera GTS	Panamera Turbo
Weights			
Unladen weight (DIN)	2,095 kg	1,925 kg	1,970 kg
Unladen (EC) ¹⁾	2,170 kg	2,000 kg	2,045 kg
Permissible gross weight	2,580 kg	2,500 kg	2,500 kg
Max. additional load	485 kg	575 kg	530 kg
Performance			
Top speed	270 km/h	288 km/h	305 km/h
0–100 km/h	5.5 secs	4.4 secs ²⁾	4.1 secs (3.9 secs) ²⁾
Overtaking acceleration 80–120 km/h	3.4 secs	3.1 secs	2.6 secs
Fuel consumption/emissions^{3)/} efficiency classes⁴⁾			
Fuel grade	Super unleaded (RON 95)	Super Plus unleaded (RON 98)	Super Plus unleaded (RON 98)
Urban (in l/100 km)	–	15.2	14.9
Extra urban (in l/100 km)	–	7.5	7.8
Combined (in l/100 km)	3.1	10.3	10.4
CO ₂ emissions g/km	71	239	242
Combined power consumption (in kWh/100 km)	16.2	–	–
Efficiency class (Germany) ⁴⁾	A+	F	F
Efficiency class (Switzerland) ⁴⁾	E	G	G
Dimensions			
Length	5,015 mm	5,015 mm	5,015 mm
Width (with exterior mirrors)	1,931 mm (2,114 mm)	1,931 mm (2,114 mm)	1,931 mm (2,114 mm)
Height	1,418 mm	1,408 mm	1,418 mm
Wheelbase	2,920 mm	2,920 mm	2,920 mm
Luggage compartment volume (German Car Manufacturers' Assoc.) with folded down rear seats	335 litres	445 litres	432 litres
Tank capacity	1,153 litres	1,263 litres	1,250 litres
	80 litres	100 litres	100 litres

Tyre type	Size	Fuel efficiency class/ rolling resistance	Wet grip class	External rolling noise* (class)	External rolling noise (dB)
Panamera					
Summer tyres	245/50 ZR18	E-C	A		73-71
	275/45 ZR18	E-C	A		75-72
	255/45 ZR19	E	A		71
	285/40 ZR19	E-C	A		73-72
	255/40 ZR20	E-C	B-A		73-71
	295/35 ZR20	E-C	B-A		74-73
All-season tyres	255/45 R19	E-B	C-B		73-72
	285/40 R19	E-B	C-B		74-72
	255/40 R20	C-B	C-B		73-72
	295/35 R20	C-B	C-B	 - 	74-72

* For logistical and technical reasons relating to the production process, we are unable to accept orders for a particular make of tyre.

*  Quiet rolling noise,  Moderate rolling noise,  Loud rolling noise.



Index

A		D	
Active bonnet system	78	Design	10
Adaptive air suspension	65	Direct fuel injection (DFI)	53
Adaptive cruise control	102	DVD audio drive	92
Air conditioning	87, 91	E	
Airbags	78, 88	Electric motor	32
All-wheel drive	60	Electronic logbook	96
Anti-theft protection	106	Emission control	57
Audio systems	92, 98, 136	Engineered body design	78
Auto start/stop function	54	Engines	52, 53
Axle concept	60, 78	Environment	81
B		Exhaust system	57
BOSE® Surround Sound System	98, 136	Exterior	10, 122
Brake (PCCB)	76, 126	F	
Brakes	77	Factory collection	141
Burmester® High-End Surround Sound System	98, 136	Fuel system	53
C		H	
CD/DVD autochanger	92	Headlight cleaning system	73
Chassis	60	Headlights	72, 74
Coasting	33, 54	Height adjustment	65
Colours	112	High-voltage lithium-ion battery	14, 32
Cruise control	102	Hybrid module	14, 30, 32, 35

I		L	
Interior	12, 84, 116, 130	Lane Change Assist	105
Interior lighting	84, 86	Lane Departure Warning	105
Interior lighting package for rear compartment	86	Launch Control	68
Interior packages	113, 133–135	LED main headlights including Porsche Dynamic Light System Plus (PDLS+)	74, 123
M		Levelling system	65, 68
Memory package	88, 130	Light-alloy construction	78, 81
Mobile phone preparation	97	Lighting system	72, 74
MP3	92, 95, 98	Lights	84–88
Multifunction steering wheel	59, 62	Lightweight exhaust system	57
N		Loading options	109
Navigation	92, 93	Luggage compartment	23, 108, 109
O		P	
On-board computer	62, 64	Parallel plug-in hybrid	14, 30
Online services	97	ParkAssist	102, 122
P		Parking brake, electric	77
Porsche Ceramic Composite Brake (PCCB)	76, 126	Payload	150
Porsche Communication Management (PCM)	92	Personalisation	110, 120
Porsche Doppelkupplung (PDK)	58	Porsche Active Safe (PAS)	102
Porsche Dynamic Chassis Control (PDCC)	66, 127	Porsche Active Suspension Management (PASM)	65
Porsche Dynamic Light System (PDLS)	73	Porsche Car Configurator	139
Porsche Dynamic Light System Plus (PDLS+)	74, 123	Porsche Car Connect	34, 100
Porsche Entry & Drive	106		
Porsche Rear Seat Entertainment Plus	94		
Porsche Side Impact Protection System (POSIP)	78		
Porsche Stability Management (PSM)	67		
Porsche Torque Vectoring Plus (PTV Plus)	67		
Porsche Traction Management (PTM)	61		
Porsche Vehicle Tracking System	101		
Power meter	30, 34		

M		R	
Memory package	88, 130	Radio	92, 95, 97
Mobile phone preparation	97	Rear hatch	109
MP3	92, 95, 98	Recuperation	32
Multifunction steering wheel	59, 62	Recycling	81
N		Reversing camera	102
Navigation	92, 93	Roll-up sunblinds	87, 109, 131
O		Roof transport system	124
On-board computer	62, 64	S	
Online services	97	Safety	73
P		Seat belt system	78
Porsche Ceramic Composite Brake (PCCB)	76, 126	Seat heating and ventilation	91
Porsche Communication Management (PCM)	92	Seats	88, 130
Porsche Doppelkupplung (PDK)	58	Slide/tilt sunroof	124
Porsche Dynamic Chassis Control (PDCC)	66, 127	Soft close doors	87
Porsche Dynamic Light System (PDLS)	73	Speed limit indicator	104, 105
Porsche Dynamic Light System Plus (PDLS+)	74, 123	SPORT button	68
Porsche Entry & Drive	106		
Porsche Rear Seat Entertainment Plus	94		
Porsche Side Impact Protection System (POSIP)	78		
Porsche Stability Management (PSM)	67		
Porsche Torque Vectoring Plus (PTV Plus)	67		
Porsche Traction Management (PTM)	61		
Porsche Vehicle Tracking System	101		
Power meter	30, 34		

P		T	
Porsche Ceramic Composite Brake (PCCB)	76, 126	Technical data	146
Porsche Communication Management (PCM)	92	Telephone module	96, 137
Porsche Doppelkupplung (PDK)	58	Thermally insulated glass	87
Porsche Dynamic Chassis Control (PDCC)	66, 127	Thermally and noise insulated glass	87
Porsche Dynamic Light System (PDLS)	73	Tiptronic S	58
Porsche Dynamic Light System Plus (PDLS+)	74, 123	Touchscreen	92, 95
Porsche Entry & Drive	106	Towbar system	125
Porsche Rear Seat Entertainment Plus	94	Transmission	58
Porsche Side Impact Protection System (POSIP)	78	TV tuner	93, 137
Porsche Stability Management (PSM)	67	Tyre Pressure Monitoring (TPM)	64
Porsche Torque Vectoring Plus (PTV Plus)	67	Tyre table	152
Porsche Traction Management (PTM)	61	U	
Porsche Vehicle Tracking System	101	Universal audio interface	92, 95
Power meter	30, 34		
Power output	14, 21, 27, 33, 41, 47		
Power steering Plus	62		
Privacy glazing	87, 124		
Protection System (POSIP)	78		
Steering	62		
Steering wheels	62		
Surround sound system	98, 136		
Surround View	102		

R		V	
Radio	92, 95, 97	Variable camshaft control	54
Rear hatch	109	VarioCam Plus	54
Recuperation	32	Voice control system	95
Recycling	81	W	
Reversing camera	102	Wheels	64, 128
Roll-up sunblinds	87, 109, 131		
Roof transport system	124		
S			
Safety	73		
Seat belt system	78		
Seat heating and ventilation	91		
Seats	88, 130		
Slide/tilt sunroof	124		
Soft close doors	87		
Speed limit indicator	104, 105		
SPORT button	68		

T		V	
Technical data	146	Sport Chrono Package	59, 62, 68, 126
Telephone module	96, 137	SportDesign steering wheel	62
Thermally insulated glass	87	Sports exhaust system	57, 127
Thermally and noise insulated glass	87	Steering	62
Tiptronic S	58	Steering wheels	62
Touchscreen	92, 95	Surround sound system	98, 136
Towbar system	125	Surround View	102
Transmission	58		
TV tuner	93, 137		
Tyre Pressure Monitoring (TPM)	64		
Tyre table	152		
U			
Universal audio interface	92, 95		

